

# Hydrema 912



# TABLE OF CONTENTS

---

<b>INTRODUCTION</b> .....	1
<b>MACHINE IDENTIFICATION</b> .....	2
<b>SAFETY</b> .....	4
<b>SERVICE</b> .....	11
<b>MACHINE DATA</b>	
Dimensions/weight/capacity .....	12
Chassis .....	13
Steering system .....	13
Brakes/axles .....	13
Wheels .....	14
Engine/cooling system .....	14
Transmission/gearshift .....	15
Hydraulic system .....	15
Electrical system .....	16
Cab .....	17
Dumper body .....	17
<b>OPERATION</b>	
Cab .....	18
Heating and ventilation system .....	19
Air conditioning .....	20
Operator's seat .....	20
Arrangement of operator's cab .....	21
Start of engine .....	31
Gearshift .....	32
Driving .....	34
Material density chart .....	36
Towing .....	37
Transport .....	38
Special conditions .....	39
Out of use / storage .....	40
<b>EQUIPMENT</b>	
Multi-tip .....	41
Towing hook .....	42
<b>LUBRICATION AND MAINTENANCE</b>	
Lubrication in general .....	43
Engine .....	45
Fuel system .....	46
Air filter .....	48
Cooling system .....	49
Transmission .....	51
Axles .....	52
Brakes .....	53
Electrical system .....	54
Hydraulic system .....	58
Cab .....	60
Lubricants .....	61
Lubrication charts .....	62
<b>TROUBLE SHOOTING</b> .....	64

The purpose of this manual is to assist you to get to know your Hydrema machine in the best possible way so that you can operate and maintain the machine safely and effectively.

Please read your manual carefully before using the machine and always keep the manual in the special pocket in the ceiling lining of the cabin.

The manual is divided into three sections:

First section - general instructions,  
second section - operation, and  
third section - lubrication and maintenance.

The life, the performance and the reliability of the Hydrema machine is highly dependent on the regular service checks indicated at the instrument display and described in this manual.

Through the descriptions in this manual you will be able to make a lot of the service and maintenance work yourself.

In case of problems you cannot solve yourself please do not hesitate to contact the local service department, and you will get the best possible assistance.

We welcome you as owner of a HYDREMA machine, and we feel convinced that HYDREMA will fulfil your expectations.

## **A/S HYDREMA**

*With Hydrema's continuous expansion and product development in mind we reserve the right to alterations.*

*1st Edition*

1. Front frame
2. ROPS/FOPS safety cab
3. Dumper body
4. Dumper body support device
5. Pivot/steering cylinders
6. Pivot safety lock
7. Hydraulic oil tank
8. Tool box
9. Bonnet
10. Rear frame
11. Pendulum bar
12. Stabilizer
13. Fuel tank
14. Battery box

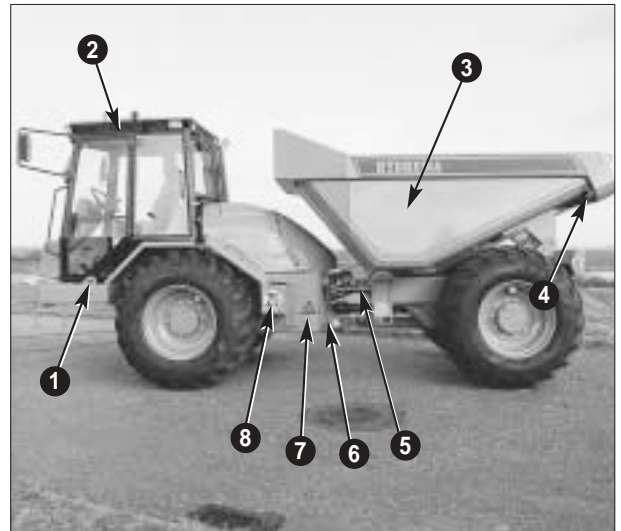

Fig. 1

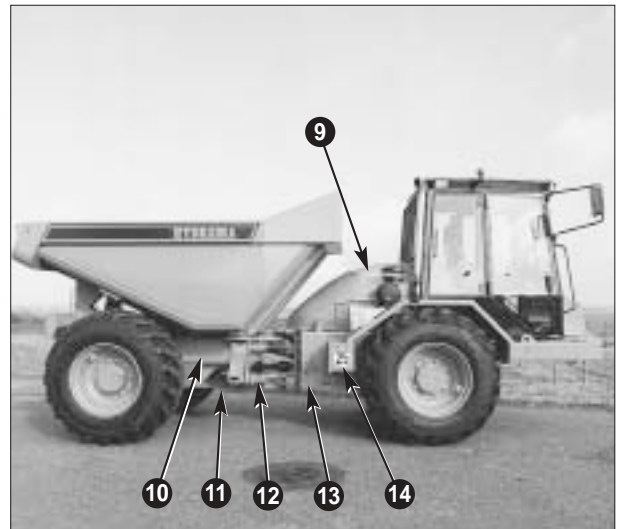

Fig. 2

Year, type and number can be read on the type inscription plate fig. 3. This information must be stated when enquiries are made to authorised workshops.

Machine no. : \_\_\_\_\_



Fig. 3 Machine type inscription plate

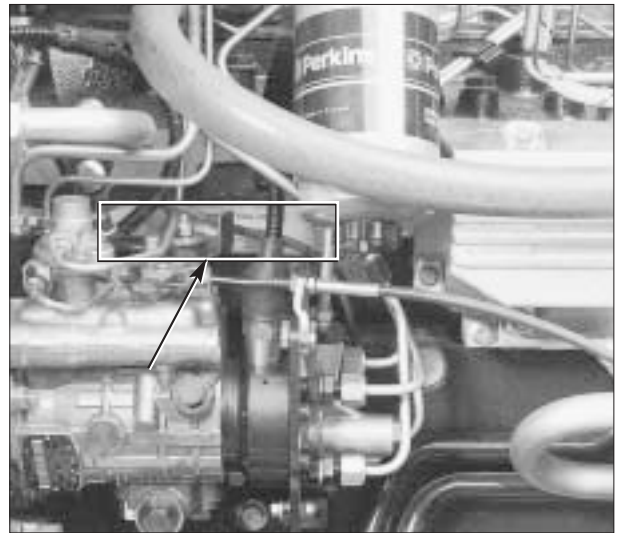

Fig. 6 Engine no.



Fig. 4 Chassis no.



Fig. 7 Transmission no.



Fig. 5 Cabin type inscription plate



Fig. 8 Axle type no.

## SAFETY IN GENERAL

Most accidents happen because of simple and elementary safety precautions not being observed. Accidents can often be averted if the operator avoids bringing himself and his machine into risky situations.

Wrong use or wrong operation of the machine may result in accidents.

Do read the Operator's Manual/safety notices and make yourself acquainted with all safety precautions and warnings before entering and working with the machine. Ignoring the instructions or warnings may cause injuries or death.

The fundamental safety precautions and warnings are described in the manual/safety notices and warning signs are placed on the machine.

In this manual and on the machine you will find safety notices. Each notice starts with a signal ward. The meaning is given below:



denotes an extreme danger exists. If proper precautions are not taken, it is highly probable that the operator could be killed or seriously injured.



denotes a danger exists. If proper precautions are not taken, the operator could be killed or seriously injured.

### IMPORTANT!

denotes a reminder of safety practices. Failure to follow them could result in injuries or damages to the machine.

### General precautions:



#### Clothing

Do not use loose-fitting clothes or jewels that may catch the control levers etc. Safety foot wear, protective helmet, working gloves, ear protectors etc. may also be necessary to protect yourself.

If you usually wear glasses, make sure that you wear them when reading the safety decals. They are strategically placed on the machine to remind you of possible hazards.

Do not overstretch or place yourself in dangerous positions to read the decals or during maintenance working.



#### Visibility

Accidents can be caused by working in poor visibility. Keep windows clean and use the lights of the machine to improve the visibility. Do not operate the machine, if you cannot see properly.



Prepare yourself to act in an emergency situation. Always keep a first aid box and a fire extinguisher available and be familiar with the use of it.



Be sure you know the hand signals used at the site. Follow the directives from the responsible foreman, signs etc. Be sure you know the rules, laws and necessary safety equipment for driving on public roads.

### IMPORTANT!

If the machine is registeret for driving on public roads with a specified load capacity then be sure to know about it.



If the way of operation is not specifically recommended, the operator himself must make sure that it can be carried out without damage to person or machine. It is the operator's duty to make sure that running the machine is not dangerous to other persons and surroundings.

**Safety equipment:****ROPS/FOPS Structure**

The machine is fitted with a Roll Over Protection Structure (ROPS) and a Falling Objects Protection Structure (FOPS). You could be killed or seriously injured, if you operate the machine with a damaged or missing ROPS/FOPS. If the ROPS/FOPS has been in an accident, do not use the machine until the structure has been renewed. Modifications and repairs that are not approved by the manufacturer may be dangerous and will invalidate the ROPS/FOPS certification.

**Machine condition**

A defective machine can result in injuries. Do not operate a machine which is defective or is missing any parts.

**Machine limitation**

Operating the machine beyond its design can damage the machine. It can also be dangerous. Do not try to upgrade the machine performance with modifications not being approved.

**Fire**

If the machine is equipped with a fire extinguisher, make sure it is checked regularly. Keep it in the operator's cab.

**Seat belt**

Always fasten your seat belt before you drive. Check the tightness and condition of the seat belt securing bolt regularly.

**Material, liquids, gas:****Battery**

The battery electrolyte contains corrosive sulphuric acid. Remove immediately if by

accident applied to the skin. Wash with cloths and plenty of water, if the fluid gets into the eyes or other sensitive parts of the body. Apply plenty of water and call for a doctor.

**Danger of explosion**

Due to voltage drop the battery may explode, if a fully charged battery is connected to a completely or partly discharged battery. Avoid sparks and open fire near the battery.

**Danger of corrosion!**

The battery electrolyte contains corrosive sulphuric acid! Avoid direct contact!

**Diesel fuel**

Diesel fuel is flammable. Keep naked flames away from the machine. Do not smoke while refueling the machine or working on the machine. Stop the engine. Failure to follow the instructions can result in injury or fire.

**Oil**

Oil is toxic. If you swallow oil, do not induce vomiting, seek medical advice. Used engine oil contains harmful contaminants which can cause skin cancer. Do not handle used engine oil more than necessary. Always use barrier cream or wear gloves to prevent skin contact. Wash skin contaminated with oil thoroughly in warm soapy water. Do not use gasoline, diesel fuel or paraffin to clean your skin.

**Warm oil**

Warm oil may cause scalds. Avoid direct contact.

**Exhaust gas**

Exhaust gas can be deadly. when working with the machine in a closed room take care that the room is well ventilated.



**Before you begin:****Loose objects**

Remove all loose parts from the place near the operator's seat and from the machine. Loose parts may block the control levers and can cause accidents.



Check that all doors, covers and caps are closed or placed as they should.

**IMPORTANT!**

Every day before starting take a walk around the machine and check that there are no leaks of oil etc.

**Round the machine**

Check that there are no foreign parts or oil on the step and the cab handle, because it may cause accidents. When getting into and off the machine always turn towards the machine and use the step and the handle.

**Start**

The engine must be started only from the operator's seat. Attempts to start by short-circuiting the starter may involve accidents, because the safety system of the machine is put out of action. It may also damage the electrical system.

**Before you drive the machine:****Functions**

Check that all control devices function normally and that the machine works as it should. Do not drive with the machine until the pilot lamp for the brake system turns off. When working after nightfall, check that all lamps and lights function as they should.

**Seat belt**

Fasten your seat belt before you drive.

**Other persons**

Never let other persons enter the machine. Unauthorized persons may fall off or cause accidents. Pay attention and always watch keenly where other workers are. Keep other persons at a safe distance from the machine.

**Practice**

You and others can be killed or seriously injured, if you do unfamiliar operations without first practising them. Practise away from the work site on a clear area. Keep other people away. Do not perform new operations until you are sure you can do them safely.

**Regulations**

Obey all laws, work site and local regulations which affect you and your machine.

**Driving:****Brake pressure**

Do not drive the machine until the brake system pilot lamp turns off. Take care that no one stays near the machine.

**Driving**

Always adapt speed to conditions. Drive slowly downhill, in turnings and in uneven terrain, otherwise the machine may roll over.

**Terrain**

Do not work in risky terrains such as ditches, projecting slopes etc. Take a walk in the working terrain before starting and see if there should be any special elements of danger.





### Driving on slopes:

To ensure driving without danger of rolling over you yourself must evaluate, whether weather conditions, road or terrain conditions allow to work safely on slopes or in uneven terrain.



### Roll over

Should the machine start to roll over, DO NOT TRY TO JUMP OUT OF THE CAB. STAY IN THE CAB WITH YOUR SEAT BELT FASTENED. Never drive on slopes with a gradient as large as the roll-over angle. Special attention is to be paid, if the terrain is uneven. Whenever possible drive always parallel to the slope.



### Gear selector

Never put the gear selector into neutral position when running downhill as it may damage the transmission.



### Dumper body

Never drive with lifted dumper body. The visibility would be restricted and the stability reduced.



### Alarm

In case of alarm always stop the machine and stop the engine at once. It is for example dangerous to drive with low brake pressure.

### Loading material:



### Weight

Never drive with excessive loads. The driver is responsible for the machine being properly loaded. The max. loading capacity is 10000 kg. This capacity results from materials with a density of 1800 kg per m<sup>3</sup> being loaded to the upper edge of the dumper body and a heaped gradient of 2:1. If the material is heavier, the dumper body must not be totally filled up. See page 36 'Material density chart'.



It is dangerous to drive with loads exceeding the indicated capacity.

### Unloading of material:



Do not reverse too near to a slope. Pay attention to the fact that the rear axle load is increasing when the load is being tipped, especially when the material does not slip easily, or if there is any risk that the material is frozen up.

Place the machine in non-articulated position before starting with the tipping.



Take care that there is room enough upwards when the dumper body is tipping. Max. height when tipped is 4.22 m (4.45 for multi-tip).



When the dumper body is tipped the weight on the wheels on that side increases.

### Before you leave the machine:



Before parking the machine and leaving the operator's seat always lower the dumper body. Activate the parking brake, stop the engine and remove the ignition key.

Never leave the machine with the gear selector in forward or reverse position. Always turn towards the machine and use handle and step when you leave the cab. Take it easy and do not jump off the machine.

**Special conditions:****Towing**

Service brake and steering mechanism do not function when towing with a dead engine. Never tow on public roads or with load.

**Transport**

It can be deadly dangerous to transport the machine, if it is not properly fastened to the trailer.

When lifting the machine make sure the lifting equipment is in good condition and certified to the lifting capacity.



It is important that the safety bar and safety bolt for turning the dumper body (if 3-side tip) is mounted during the transport of the machine.

**Starting with auxiliary battery:****IMPORTANT!**

Reverse polarity may damage the voltage relay and alternator.

**Danger of explosion!**

Due to voltage drop the battery may explode, if a fully charged battery is connected with a partly or completely discharged battery. Avoid sparks and open fire close to the battery.

**Danger of corrosion!**

The battery electrolyte contains corrosive sulphuric acid! Avoid direct contact!

**Starting the engine**

The engine must be started only from the operator's seat. Attempts to start the engine by short-circuiting puts the start bar of the machine out of action which can cause accidents.

**IMPORTANT!****Ether**

Ether start must not be used at the same time as the preheater.

**Lubrication and maintenance:**

Incorrect lubrication and maintenance of the machine can make it dangerous to work with. It is therefore very important that the operator is thoroughly familiar with the procedure in view of lubrication and maintenance before he begins with the maintenance work.

The procedure recommended for lubrication and maintenance is described in chapter LUBRICATION AND MAINTENANCE.

Follow safety instructions and safety notices placed on the machine.



Use original or certified parts only.



The operator is responsible for correct operation and maintenance.

**In general**

Before you start lubrication and maintenance make sure that

- the machine stands on a plane surface.
- the gear selector is in neutral position.
- the ignition key is removed - unless the transmission oil level has to be checked.
- the pivot safety lock is mounted.
- the support device is mounted, when the dumper body is tipped.

**Bonnet**

Do not open while the engine is running.



### Warm components

Hot oil and hot components may cause scalds and burns - avoid direct contact!



### Oil

Oil is toxic. If you swallow oil, do not induce vomiting, seek medical advice. Used engine oil contains harmful contaminants which can cause skin cancer. Do not handle used engine oil more than necessary. Always use barrier cream or wear gloves to prevent skin contact. Wash skin contaminated with oil thoroughly in warm soapy water. Do not use gasoline, diesel fuel or paraffin to clean your skin.



### Warm oil

Warm oil may cause scalds. Avoid direct contact.



### Hydraulic pressure

Hydraulic oil/diesel fuel being under pressure may penetrate the skin and cause serious harm. Before disconnecting or connecting hydraulic hoses, stop the engine to release the pressure trapped in the hoses. Make sure the engine cannot be started while the hoses are open.

### IMPORTANT!

When servicing the hydraulic system always release the system pressure by loosening the filler cap. It is imperative that the machine is clean as any amount of impurity may ruin the hydraulic components and cause a breakdown.



### Release of hydraulic pressure

At working temperature the hydraulic tank is under pressure. Warm oil may cause serious scalds.

Remove filler cap only when the engine is stopped and the tank is cool.

The hydraulic system for the tipping function and the brake system of the machine may be under pressure when the engine is stopped. Before any kind of repair/service make sure

that the systems are entirely pressure-released (see page 59).



### Diesel fuel

Diesel fuel is flammable. Keep naked flames away from the machine. Do not smoke while refueling the machine or working on the engine. Failure to follow the instructions can result in injury or fire.



### Cooling system

The coolant may cause skin irritation.



The cooling system is working under pressure, therefore it is dangerous to remove the cover while the system is hot. Always turn the cover carefully to allow for release of pressure, and only remove the cover after excessive fluid has disappeared.



### Cleaning the cooler

Having brushed off the dry dirt clean the radiator from the engine side with compressed air.



Use dust mask and goggles.



### Air filter

Use dust mask and goggles. when cleaning with compressed air.

### IMPORTANT!

The pressure must not exceed 205 MPa (2 bar), higher pressure may damage the filter. Never mount a wet filter element. It may damage the engine.



### Wheels

Place yourself beside the wheel when pumping up wheels with lock ring. Use of self-locking nozzle is recommended.



### Start with auxiliary battery

- Check that the auxiliary battery has a voltage of 12 V.
- Connect the jump leads to the positive pole on the battery of the machine. Take care that the jump lead battery terminal does not touch the frame.
- Connect the jump leads to the positive pole of the auxiliary battery.
- Connect the jump leads to the negative pole of the auxiliary battery and the other end to the machine's chassis - away from the battery. It may for example be connected to the step or direct to the engine block at the mounting bolt of the starting motor.



### Starting the engine

The engine must be started only from the operator's seat. Attempts to start the engine by short-circuiting puts the start bar of the machine out of action which can cause accidents.



### Charging the battery

When the battery is charged, an explosive kind of gas generates.



#### **Danger of explosion!**

Due to voltage drop the battery may explode, if a fully charged battery is connected to a completely or partly discharged battery. Avoid sparks and open fire near the battery.



#### **Danger of corrosion!**

The battery electrolyte contains corrosive sulphuric acid! Avoid direct contact! Short circuit, open fire or sparks near the battery may cause a heavy explosion. Always cut off the charge current before removing charge terminals from the battery. Ventilate carefully, especially when charging in a closed room.



### Electrical circuit

Understand the electrical circuit before connecting or disconnecting an electrical component. A wrong connection can cause injury and/or damage.



### Raised dumper body

Never walk under a raised dumper body before the support device is mounted.



### Soft ground

On soft ground the machine may begin to sink. Never work under a machine on soft ground.

**Remember: BE CAREFUL  
BE ALERT  
BE SAFE !**

## SERVICING

Before leaving the factory the machine has been carefully tested and adjusted. However, in the beginning it is important to make further checks. Retightening of bolts, check of adjustments etc. are to be performed.

Therefore, HYDREMA will service your machine after 50 and 200 hours' operation respectively. When the instrument display indicates these hours, please inform you Sales and Service Department.

## SERVICE AND COMPLAINTS

Within 12 months from delivery HYDREMA replaces parts due to defects in material, fitting or manufacturing.

Replacement will not occur in case of normal wear or due to non-observance of suppliers's instructions, in case unoriginal parts have been applied or repair has been made by other workshops than the ones approved by the supplier.

For loss of profit and other indirect losses in connection with a standstill no compensation will be made by HYDREMA.

For electrical components, tyres and hoses etc. the respective manufacturer's service and complaint conditions will be in force.

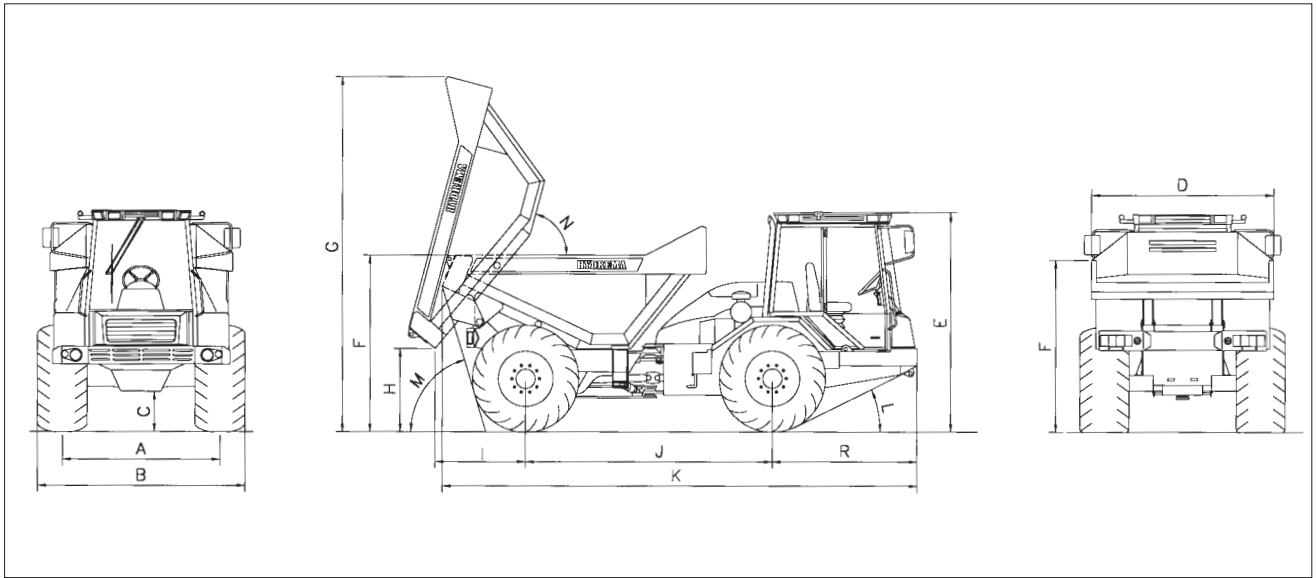

Fig. 11







**DIMENSIONS**

	mm
A. Track	1860
B. Overall width, standard tyres	2470
Width over optional tyres	2200
C. Ground clearance	400
D. Width dumper body	2210
E. Max. height	2660
F. Loading height	2170
G. Total tipping height	4215
H. Tipping clearance	1050
I. Rear overhang	1100
J. Wheel base	3030
K. Overall length	5800
L. Front departure angle	27°
M. Rear departure angle	73°
N. Tipping angle	75°
Body capacity	5,6 m <sup>3</sup>
Turning radius	6,0 m

**WEIGHT**

	kg
Total weight	16500
Unladen weight	6500
Carrying capacity	10000
Front axle load, unladen	3800
Rear axle load, unladen	2700
Front axle load, laden	6000
Rear axle load, laden	10500

**CAPACITIES**

	litres
 Engine oil	9,0
 Transmission oil	17,5
Oil change	12,0
 Differential oil	2x14,0
Hub oil	4x 1,3
 Coolant	36,0
 Hydraulic oil	110, 0
Tank	90,0
 Fuel tank	140,0

## CHASSIS

Articulated chassis consisting of two main parts, the front frame and the rear frame. The frames are connected in the pivot at the top and in the pendulum bar with two hydraulic stabilizers at the bottom. Hydraulic tank and fuel tank are integrated in the front frame.

Max. working pressure of the stabilizers:	68 bar (6.8 MPa)
Oscillating angle between front and rear frame:	±12°

## STEERING SYSTEM

Hydrostatic pivot steering with two double acting steering rams with end brakes.

Priority valve:	Danfoss OLS Load Sensing
Oil pump:	36 cm <sup>3</sup> shared with working hydraulics
Steering unit Orbitrol, type:	Danfoss OSPD 80/395
Steering pressure, max.:	160 bar (16 MPa)
Overload pressure max.:	210 bar (21 MPa)
Steering angle:	±35°

The machine is equipped with an emergency steering system. In case of loss of oil supply from the steering pump, a red warning lamp is turned on in the instrument display.

## AXLES

Rigid, heavy duty axles with planetary hub reduction. Automatic limited slip differential lock on the rear axle. Integrated self-adjusting disc brakes. Separate oil chambers for differential and hubs.

Ratio:	19:1
--------	------

## BRAKES

The service brake is a fully hydraulic servo dual circuit system. The self-adjusting oil-immersed disc brakes are integrated in the axles.

Oil pump:	10 cm <sup>3</sup>
Brake pressure front and rear axle:	23 bar (2.3 MPa)

 Parking brake:	
electric/hydraulic activation:	Fail-safe integrated in the front axle





## WHEELS

Type	TYRES Dimension	RIM Dimension	LOAD INDEX Min.	SPEED-INDEX Min.	RECOMMENDED TYRE PRESSURE	
					Front	Rear
Twin	600/55-26,5	20x26,5	168	A8	2,0 bar (200 kPa)	2,7 bar* (270 kPa)
EM	17,5R25	14.00/1,5x25	168	A8	2,75 bar (275 kPa)	5,25 bar (525 kPa)

\* 3.2 bar when driving for a long time with full tyre load on a hard surface  
Tightening torque of wheel nuts: 500 Nm (50 kpm)



Always place yourself beside the wheel when pumping wheels with lock ring. Use of self-locking nozzle is recommended.



## ENGINE

The machine is equipped with a 4-litre diesel engine with turbo-charger and intercooler. The engine has high torque, low fuel consumption and low exhaust emission which complies with 97/68 EG Stage 1.

Type:	Perkins 1004-40TW
Output at 2200 rpm:	90.5 kW (123 HP) ISO/TR 14396
Torque at 1500 rpm:	434 Nm
Number of cylinders:	4
Cylinder bore/stroke:	100/127 mm
Compression ratio:	17.25:1
Adjustment of revolution, min.	780 rpm
max.	2310 rpm



## Cooling system

The machine is fitted with a closed water cooling system. The circuit contains a heat exchanger for cooling the transmission oil. The induction air is also cooled by the coolant in the intercooler.

Normal coolant temperature:	82-88°C
Acoustic alarm at:	103°C



## Air filter

Dry air filter with safety filter and cyclone type induction cap.

Electric indicator for clogging:	7.5 kPa
----------------------------------	---------



## TRANSMISSION

The machine has a powershift transmission with converter and ergo power shift system. It has 6 forward and 3 reverse gears. The electronic gearshift system is automatically controlled but can also be operated manually.

Type ZF 6WG 110  
 Stall torque ratio: 1.87:1  
 Gears: 6 forward, 3 reverse

### Speed area:

		EMPTY	WITH MAX. LOAD
1 <sup>st</sup> gear	forward/reverse	0 - 6 kph	0 - 6 kph
2 <sup>nd</sup> gear	forward	0 - 9 kph	0 - 9 kph
3 <sup>rd</sup> gear	forward/reverse	0 - 13 kph	0 - 13 kph
4 <sup>th</sup> gear	forward	0 - 20 kph	0 - 20 kph
5 <sup>th</sup> gear	forward/reverse	0 - 29 kph	0 - 26 kph
6 <sup>th</sup> gear	forward	0 - 40 kph	0 - 38 kph

The above speeds are valid for tyres 600/55-26.5 on horizontal and plane road.



## HYDRAULIC SYSTEM

The machine is equipped with two hydraulic pumps. One pump supplies the steering mechanism and the tipping function. The oil is distributed between the two functions by means of a priority valve. The other pump supplies the service and parking brake and the hydraulic stabilizers.

Pump for steering and tipping: 36 cm<sup>3</sup> gear pump  
 Oil with priority to LS-steering  
 Working pressure 160 bar (16 MPa)  
 Working pressure/tipping 200 bar (20 MPa)

Pump for brake and stabilizers: 10 cm<sup>3</sup> gear pump  
 Working pressure 60 bar (6 MPa)

**ELECTRICAL SYSTEM**

Type	12V negative earth
Battery	12V 144Ah 800A
Alternator	65A 780W
Fuses	5A, 10A, 15A, 25A

Lamp bulbs	Consumption WATT	Socket
Headlights H4	60/55	P43t/38
Side light in front	4	BA9s
Direction indicator in front	18	S8,5
Indicator side and rear, fog light and reversing light	21	BA15s
Marker light	5	BA15s
Rear light and brake light	5/21	BAY15d
Number plate	5	S8,5
Work light H3	55	PK22s
Cab light	10	S8,5
Pilot lamps, instrumentation lamps	1,2	W2x4,6d
Warning beacon H1	55	P14,5s



## CAB

The cab is mounted on rubber elements. It is insulated and has a plane floor with rubber mat.

The cab is tested and approved as safety cab: ROPS according to 86/295EEC and 3471/1-1986, FOPS acc. to 86/296/EEC

The roof construction contains heating and ventilation system with defrosters for all windows. The fan has three speeds. The driver's seat is spring suspended and fitted with weight and height adjustment. It can be adjusted forward and backwards, and seat and back have angular adjustment. The seat is fitted with a 2-point automatic seat belt and headrest.

### Noise level:

The noise level is measured according to Directives 86/662/EEC and Direktive 95/27/EEC as well as Directive proposal for noise emission for outdoor equipment.

Noise level at driver's seat:	80 dbA
Noise level outside the machine:	106 LwA



## DUMPER BODY

The Body is made of high tensile steel for optimum wear resistance. It is fitted with two double acting rams.

For multi-tip: two single-acting telescopic cylinders, tipping angle 67°.

### Capacity:

Struck body capacity:	4.2 m <sup>3</sup> (ISO 6483)
Max. heaped body capacity	5.6 m <sup>3</sup> (ISO 6483)
Carrying capacity:	10000 kg
Tipping angle	75°
Tipping time:	6 sec

## CAB



### Getting in/out of the cab:

Always have a firm grip with both hands, or stand on both feet and reach with one hand. Always keep step, handles and footwear clean. Always face the machine when getting in and out. Never jump off the machine.

### Doors:

Automatic stop on doors. The doors can be positioned for ventilation by using the door retainer. The right-hand door is locked with internal lever. The left-hand door is locked from outside with a key.



Never drive with open doors. The door will then be the outer point of the machine.

### Windows:

The side windows can be opened for ventilation or opened entirely by using the door retainer.



Fig. 11



Fig. 12



Fig. 13

**Interior light:**

The lamp is switched on by turning the glass.

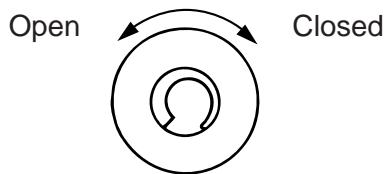

Fig. 14



**Heater/Ventilation:**

- 1. Regulation lever for heating



- 2. The air nozzles can be opened/closed and set on spindle for right air direction (Fig. 15).

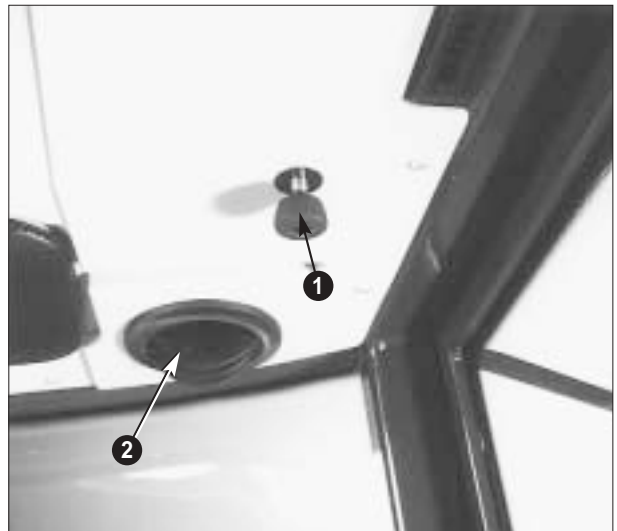

Fig. 15

- 1. Adjustment of air direction
- 2. Open/closed

If fast heating is required, the nozzles 2 fig. 15 must be completely or partly open.

The 3-speed fan is adjusted with switch 11 fig. 23.



Never drive or work with the machine before there is full view and dew or ice is completely removed from all windows.

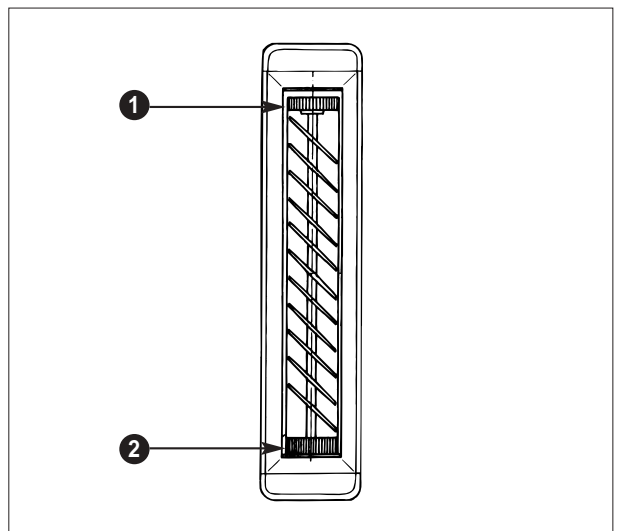

Fig. 16



## Air-conditioning

The air-condition system is operated with a fan and thermostat switch, placed in a panel in the internal roof fig.17:

1. **Fan switch with 4 positions:**  
0 for off and 1-2-3 for fan speed
2. **Thermostat switch:**  
When the switch is turned clock-wise towards "COLDER", the intake air will be cooled.

### OPERATION:

Before switching on the air-condition system, make sure that the heating tap fig.15 pos.1 is closed and that the heating fan fig.23 pos.11 is switched off.

As start position, it is suggested that the air-condition fan is set on step 2 and the thermostat is turned towards max. cooling. When the required temperature is reached, turn the thermostat back until the temperature is kept constant.

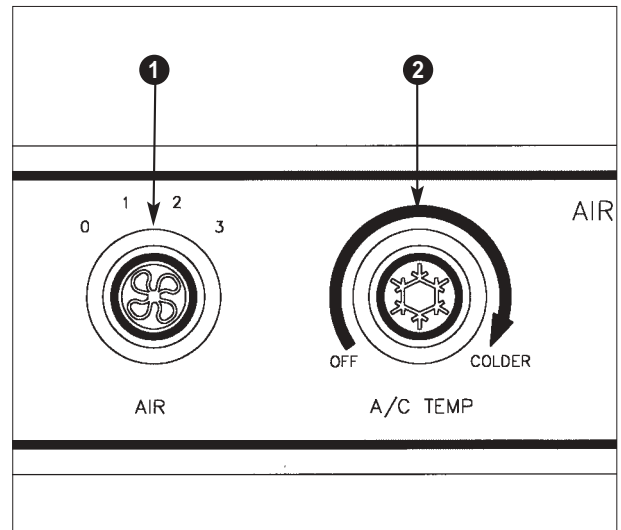

Fig. 17

### NOTE!

When the air-condition system is running, it is important that cab doors and windows are kept closed in order to keep the cooling. Even when it is very hot, the cab temperature should not be more than 8 to 10°C below outdoor temperature, for reasons of the operator's health.

## OPERATOR'S SEAT

### Adjustment:

1. **Distance**  
Pull the lever and push the seat forward and backwards.
2. **Back**  
Pull the lever and adjust to the required angle.
3. **Height**  
Pull up the levers and lift or lower the front or rear of the seat.
4. **Operator weight**  
Adjust the spring mechanism to the operator's weight.

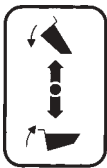

Fig. 18



**ARRANGEMENT OF OPERATOR'S CAB**

1. Dash bord fig.20
2. Side dash board fig.23
3. Brake pedal
4. Accelerator
5. Parking brake
6. Dumper body lever
7. Steering wheel
8. Plug for work lamp
9. Adjustment of steering wheel position



**Dumper body lever:**  
When pulling the lever backwards the body is tipping. This is shown in the instrument display.

When pushing the lever forward the dumper body returns to its basis position. Before putting the lever in neutral position again, be sure the hydraulic pressure in the tip cylinders is built-up again.

**Dash board:**

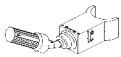

**1. Gear selector:**  
see 'Gearshift' page 32



**2. Fuel gauge:**

The fuel gauge shows the fuel level in the tank. When the tank is empty see 'Bleeding of fuel system' page 47.



**3. Temperature gauge:**  
Engine coolant

When the engine has reached normal working temperature, the gauge indicates 70-100°C. Deflections below or beyond this at normal operation could mean that the cooling system is defective. The acoustic alarm will be activated at 103°C.

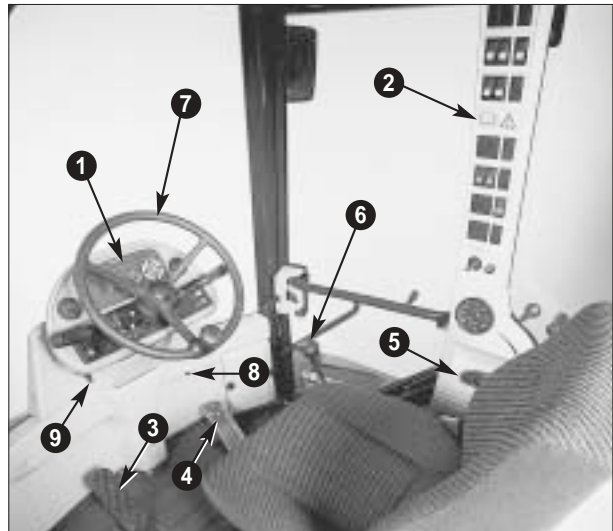

Fig. 19

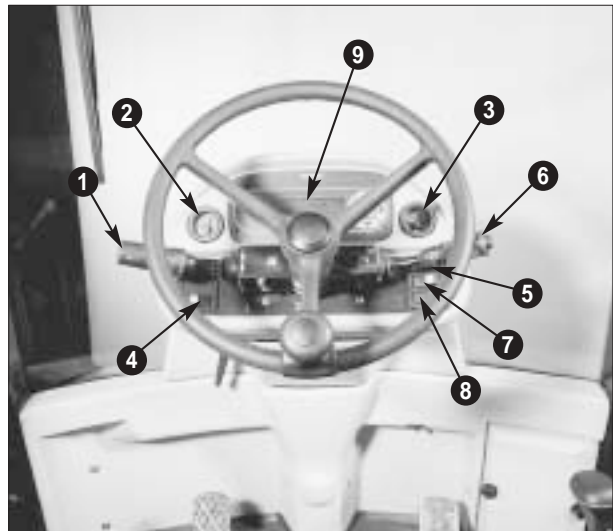

Fig. 20



**4. Gear automatics:**

Switch not activated:  
The machine always drives with manual gearshift.

Switch activated:  
Fully automatic gearshift can be selected (page 32).



5. **Switch and pilot lamp:**  
Hazard flashes

Activates all direction indicators simultaneously. Can be used without ignition. Should only be used if it is necessary to stop where the traffic may be obstructed.

6. **Combi switch:**

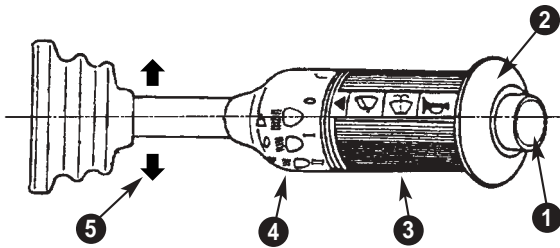

- 1. Horn
- 2. Front screen washer
- 3. Front wiper switch
  - J. Interval wiper (no standard equipment).
  - I Low speed
  - II High speed
- 4. Low beam/main beam and light signal
- 5. Direction indicator



7. **Switch and pilot lamp:**  
Rear fog light



8. **Light switch:**

The first position turns on parking and dash board lights. The second position turns on low or main beam light.

9. **Instrument display:**

The machine is fitted with a computerised instrument display with following functions:

- 1. Pilot lamps
- 2. Driving display with speedometer, kilometer counter and clock. Possibility of trip counter in the display.
- 3. Service-information with indication of checks and maintenance.
- 4. Information on service at the service dates.
- 5. Acoustic and text alarms when:
  - no steering pressure
  - too high transmission oil temperature
  - too low brake pressure
  - parking brake activated
  - too low engine oil pressure
  - too high coolant temperature
  - clogged air filters
  - dumper body lifted
- 6. Start alarm with customer code
- 7. Hire menu

PILOT LAMPS

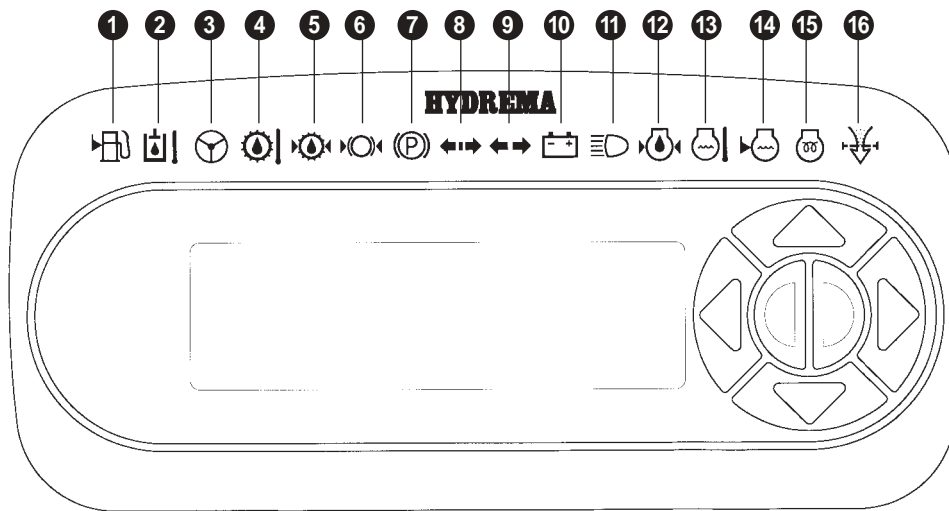



Fig. 21

 **1. Pilot lamp:**  
Fuel level

Lights when the fuel level is low (ca. 15 ltrs.) At the same time a text appears in the display.

 **2. Pilot lamp:**  
Hydraulic oil temperature  
(no standard equipment)

Lights if the hydraulic oil temperature is too high. The highest permitted oil temperature is 93°C.  
The acoustic alarm is activated and a text appears in the display.

 **3. Pilot lamp for steering pump:**

Lights, when the oil supply from the steering pump fails.

The lamp lights when turning the ignition key. When the engine is started and the pump operating, the lamp must go out.



The machine must be stopped at once, when the pilot lamp for the steering pump lights. The acoustic alarm is activated and a text appears in the display.

 **4. Pilot lamp:**  
Transmission oil temperature

Lights if the transmission oil temperature is too high. The highest permitted oil temperature is 120°C.  
The acoustic alarm is activated and a text appears in the display.

 **5. Pilot lamp:**  
Transmission oil pressure  
- not connected

See 'Gearshift' page 32

 **6. Pilot lamp:**  
Brake pressure

Lights if the brake pressure is too low. The machine must not be driven when the lamp lights.  
The acoustic alarm is activated and a text appears in the display.

 **7. Pilot lamp:**  
Parking brake

Lights when the parking brake is activated. The acoustic alarm is activated and a text appears in the display when the machine is moving.

-  8. **Pilot lamp:**  
Direction indicators, trailer

The lamp is flashing, when extra direction indicator is connected to the seven-poled plug.

-  9. **Pilot lamp:**  
Direction indicator

-  10. **Pilot lamp:**  
Charging

Lights when the alternator does not charge the battery properly. It lights when the ignition key is turned and must go out when the engine speed is increased.

-  11. **Pilot lamp:**  
Main beam head light

-  12. **Pilot lamp:**  
Engine oil pressure

Lights when the ignition key is turned or the oil pressure is too low. If so, stop the engine at once and find the cause. The acoustic alarm is activated and a text appears in the display.

-  13. **Pilot lamp:**  
Engine coolant temperature

Lights when the engine coolant temperature is too high. Highest permitted temperature is 103°C.  
Acoustic alarm is activated and a text appears in the display.

-  14. **Pilot lamp:**  
Engine coolant level  
(no standard equipment)

Lights when the engine needs coolant. Acoustic alarm is activated and a text appears in the display.

-  15. **Pilot lamp:**  
Preheater

Lights when the ignition key is turned to pos. 2 for engine preheating. The engine may be started after 15 seconds.

-  16. **Pilot lamp:**  
Engine air filter

Lights when the air filter is clogged. If the lamp lights when the engine is running, the filter must be changed or cleaned (page 48). The acoustic alarm is activated and a text appears in the display every time the engine is started.

DISPLAY KEYS

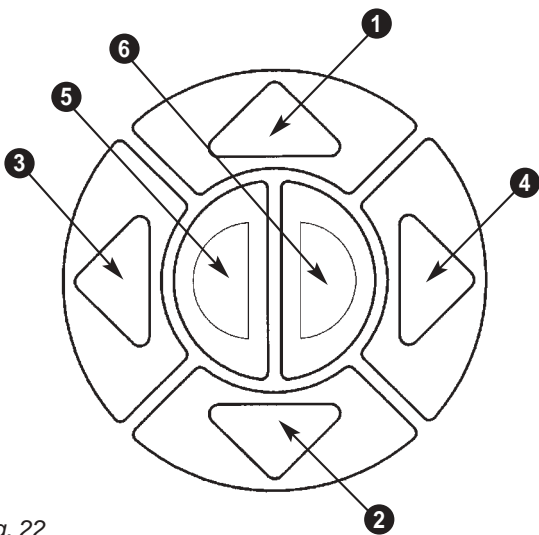
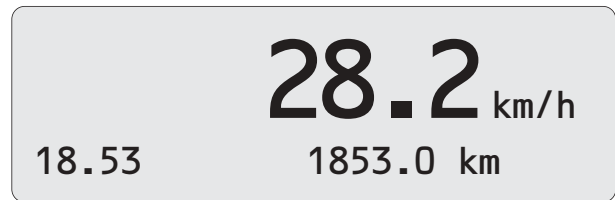

Fig. 22

- 1** The key is used for moving the display cursor upwards to a new item or to count up to larger numbers when setting clock and date.
- 2** The key is used for moving the display cursor downwards to a new item or to count down to smaller numbers when setting clock and date.
- 3** The key is used for moving the display cursor to the left.
- 4** The key is used for deleting the service item and for moving the display cursor to the right.
- 5** The RED 'ESC' key is used for returning to the driving display from any menu.
- 6** The GREEN 'ENTER' key is used for selecting menu and menu item and to confirm the setting.

DRIVING DISPLAY:



The driving display has speedometer, mileage counter and digital clock.

MAIN MENU:

Press "ENTER" key to enter the main menu, display 1:

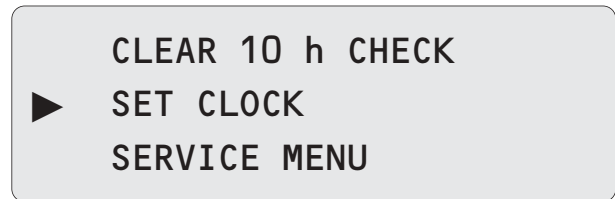

You can shift between the different menu items with key ▲ and ▼. Choose the menu item by pressing the 'ENTER' key.

For shifting to display 2 press ▼:

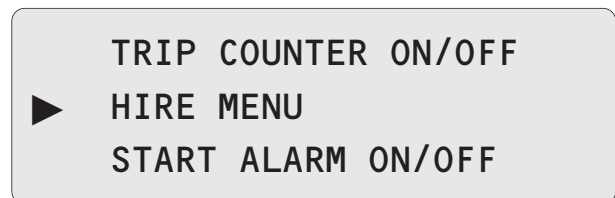

**RESET 10 H CHECK**

When choosing this item by pressing the 'ENTER' key you will get the time for the next 10 h check as well as the possibility to reset all 10 h checks. If you make daily checks, for instance in the morning, it is advantageous afterwards to reset the 10 h check. There will be no message to check for the rest of the day then. You can reset by pressing the ► key for more than half a second. If you do not want to reset, press 'ESC'.

**CLOCK SETTING**

Press the 'ENTER' key and you can set clock and date:

TIME 14.27.22  
(hour, minutes, seconds)

DATE 99.06.12  
(year, month, day)

You can move the cursor with the ◀ ▶ keys and change the individual figures with the ▲ ▼ keys. The clock will stop during the setting and can be started again with the 'ENTER' key.

When you have reached the correct setting you can confirm with the 'ENTER' key, or if you regret, press the 'ESC' key instead and you will return to the driving display. It is recommended that clock and date always are correctly set as this is of importance for the registrations of the instrument.

**SERVICE MENU**

▶ HOURS AND MILEAGE  
HYDR. OIL TEMP.  
STEERING PRESSURE

When choosing this menu you will get a number of menu items keeping important service data.

Shifts between the menu items are made with the ▲ and ▼ key, and the menu item is chosen with the 'ENTER' key.

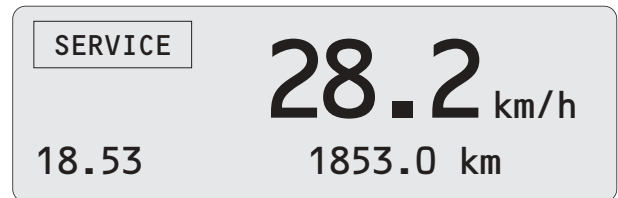
**SERVICE-CHECK DISPLAY**

When it is time for a check, according to the maintenance schedule of the machine, the information

**SERVICE** will appear in the driving display. When pressing the 'ENTER' key the service check menu appears indicating what has to be carried out.

▶ CHECK ENGINE OIL  
LEVEL  
CHECK COOLANT  
LEVEL

After the service check has been made choose the item with the ▲ and ▼ keys, and the message will be deleted when you press the ▶ key for more than half a second.

When this message has been deleted, the message

**SERVICE** in the driving display will disappear, and you will automatically return to the driving display.

If you do not want to carry out the check immediately after you have seen the message, you can - by means of the 'ENTER' key - see the items and return to the driving display by pressing 'ESC'.

The message

**SERVICE** will be kept in the driving display.

**AUTHORIZED SERVICE**

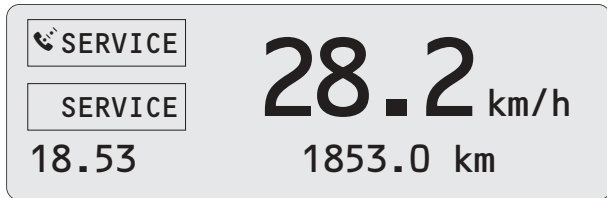

When it is time for a check, according to the maintenance schedule of the machine, the following message will appear:



When this is the case call in an authorized service for check of the machine.

 will remain in the driving display until the service has been carried out.

**ALARM DISPLAY**



In case of error messages about important functions the acoustic alarm will start and an alarm text appear in the display. The alarm text will - together with the corresponding pilot lamp - indicate where the possible defect is.



Always follow the instruction in the display. It is deadly dangerous or might involve major damage of the machine, if you continue to drive inspite of a S T O P message.

The alarm will automatically be switched off, when the error has been corrected and the machine restarted.

**TRIP COUNTER ON/OFF**

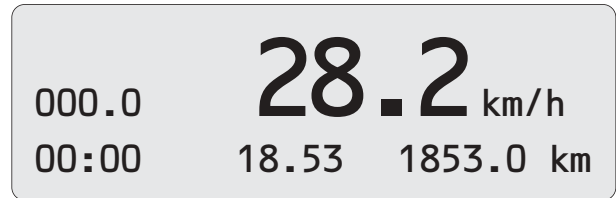

It is possible to show clock and trip counter in the display.

With the ► key pinpointing TRIP COUNTER ON/OFF in the main menu, the trip counter can be engaged and disengaged with the menu keys ◀ ▶.

If the trip counter is activated it can be reset with the red 'ESC' key.

The trip counter counts the kilometers up to 999.9 km as well as the full hours.



**HIRER MENU**

The hire menu gives information on hours, km and alarms for one job at a time. The data can be opened and read in the display.

Press 'ENTER' under 'hire menu' in the main menu to enter the next display:

```

HIRER MENU
▶ NEW JOB
  CANCEL JOB
  JOB REGISTER
  
```

When you choose NEW JOB the display asking for the customer's code appears (page 29). When the code has been given, the following confirmation display will appear (confirm with 'ENTER'):

```

START NEW JOB
▶ YES
  NO
  
```

Choosing YES will delete all data from the previous job and a new registration will begin.

Choosing NO will delete all data from the previous job, but there will be no new registration.

When NEW JOB has been chosen, the following data will be stored:

- number of hours with the engine running
- number of kilometers driven
- number of hours and km for each day
- list with the alarms logged in the period (the last 10)

When choosing INTERRUPT JOB the display asking for the customer's code appears.

When giving the right code interrupt the registration with 'ENTER' and you will go back to the driving display.

When choosing JOB REGISTER the following display appears:

```

MACHINE NO:
XX.XX.XX → XX.XX.XX
HOURS TO DATE:  XXXX
KM TO DATE:      XXXX
  
```

Press menu key ▶ to enter the next display:

```

HOURS PR. DAY
97.02.24  140 KM  07:06 H
97.02.25  108 KM  06:30 H
97.02.26   53 KM  04:25 H
  
```

With the menu keys ▲ and ▼ you can choose the day of the hour list.

With the menu key ◀ you choose the previous display.

With the menu key ▶ you choose the alarm list.



With the menu key ◀ you choose the previous display.

With the menu keys ▲ and ▼ you can turn over the alarm list.

Push the red 'ESC' key to return to the main menu.

**START ALARM**

The instrument has a built-in start alarm, which activates the acoustic alarm and flashing display text, when the machine is started by unauthorised persons.

The start alarm is engaged and disengaged with the menu keys ◀ and ▶ under START ALARM ON/OFF in the main menu, so it is possible to disengage the alarm during the day and engage it when you leave the machine.

If the start alarm is activated, the following display appears when the ignition key is turned:



Then choose the four-figure start code by rolling with the menu keys, and confirm with the green 'ENTER' key.

If you have given the right code, the usual driving display will appear.

If the code is wrong, an alarm will be activated and the following flashing display appears:



Also when the start alarm is to be disengaged the four-figure code has to be applied.

**CUSTOMER CODE**

The customer code and the start code are the same four-figure code. This code can be chosen freely by the customer and stored in the driving display upon machine delivery or later by Hydrema's service staff. This code can be changed to a different code at any time.

**DISPLAY CONTRAST (LIGHT)**

The display contrast can be adjusted according to demand. The symbol for the contrast adjustment is shown in the upper right-hand corner of the driving display.

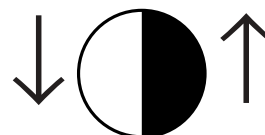



The display becomes darker when pushing the key ▲ numerously. The display becomes lighter when pushing the key ▼ numerously. The contrast can only be adjusted in the driving display.

**SIDE DASH BOARD**

- 

1. **Switch and pilot lamp:**  
Work light front
- 

2. **Switch and pilot lamp:**  
Work light rear
- 

3. **Switch and pilot lamp:**  
Warning beacon
- 

4. **Switch and pilot lamp:**  
Work light, left
- 

5. **Switch and pilot lamp:**  
Work light, right
- 

6. **Switch and pilot lamp:**  
Locking the pendling  
When the switch is activated and the lamp lights, the pendling between front and rear frame is locked in middle position (no standard equipment).

 **WARNING**

The locking of the pendling may only be applied when the machine stand still.
- 

7. **Wiper switch:**  
Rear window
- 

8. **Washer switch:**  
Front screen and rear window
- 

9. **Horn switch:**
- 

10. **Ignition key:**  
Function see 'Start of engine' page 31
- 

11. **Fan switch:**  
The switch has 4 positions:  
0 for off and 1-2-3 for fan speed
- 

12. **Tachometer:**  
Indicates the engine rpm.  
The build-in hour counter shows the number of hours driven.

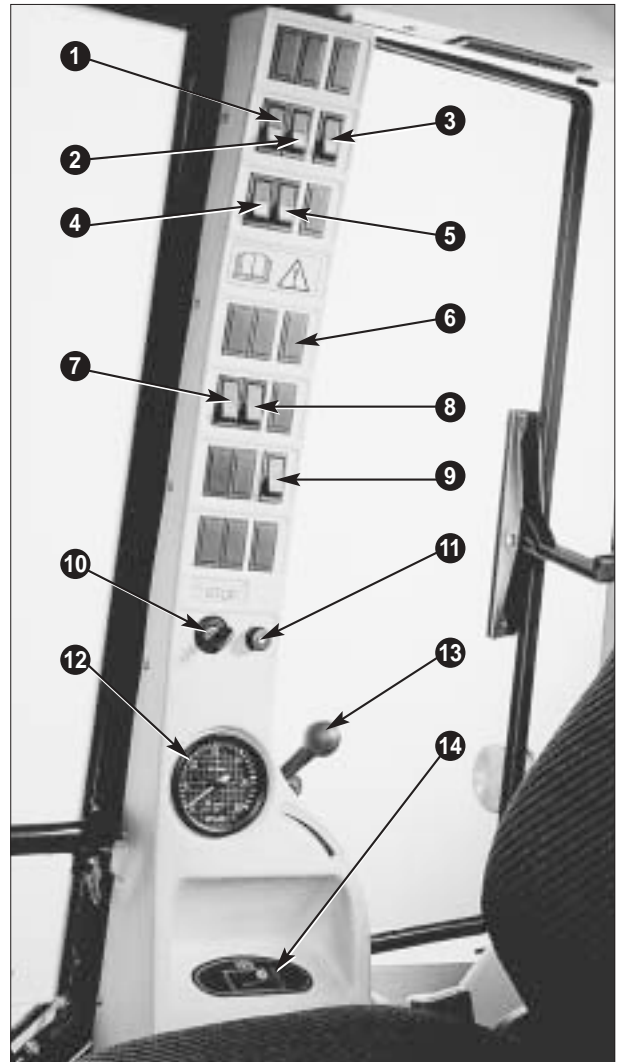



Fig. 23

- 

13. **Hand throttle:**  
Lever up = min. rpm  
Lever down = max. rpm.
- 

14. **Switch and pilot lamp:**  
Parking brake

The lamp lights, when the brake is activated. The acoustic alarm is activated and a text appears in the display if the machine is moving when applied.

**START OF ENGINE**

Check that the parking brake is activated and the gear selector in neutral position. Read 'Before you drive the machine' (page 6).

Function of ignition key:

- P – No function
- O – Stop
- I – Driving position
- II – Preheating
- III – Start

**Starting a cold engine:**

Turn the ignition key into position

- I – The pilot lamps are lit for 3 sec. Then the following lamps must light:  
Emergency steering  
Brake pressure (if too low)  
Parking brake  
Charging control  
Motor oil pressure
- II – Preheating for 15 sec.(til the text START ENGINE appears).  
Press the accelerator pedal home
- III – Aktivate starter motor  
Let go the ignition key as soon as the engine is starting.

If the engine does not start within 15 seconds, turn the key to position 0 and repeat the starting procedure.

**Starting a warm engine:**

Activate the accelerator pedal ¼ turn. Turn the ignition key to starting position III and hold it for max. 30 seconds until the engine starts.

If the start attempts are in vain: Wait until the engine stands still. Turn the ignition key to position 0, before trying to start again.

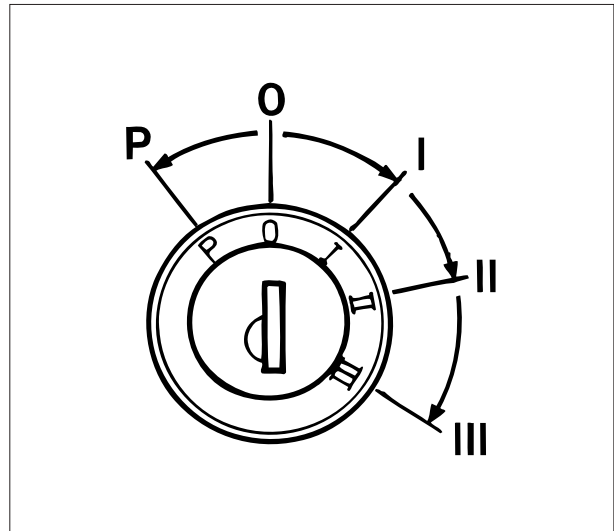

Fig. 24

**Starting in cold weather:**

The engine is equipped with a cold start system.

As long as the engine is cold (below 60°C) or the hydraulic oil is below 10°C - the engine should not run faster than 1500 rpm.

**Preheater:**

The preheater is an electrically operated device which ignites a specific amount of diesel fuel in the induction manifold to heat the induction air (fig. 24, II).

If necessary the machine can be started by an auxiliary battery or a battery of another vehicle.

**Starting with auxiliary battery:**

See 'Special conditions' page 39

## GEARSHIFT

The machine can be driven with manual or fully automatic gearshift.



Do not drive the machine until the brake system pilot lamp for the brake pressure is out.

Always fasten your seat belt before starting. Take care that no one is near the machine.

### In general:

Lever in middle position = neutral

Lever forward = driving forward

Lever backwards = driving backwards

When starting select the required speed range first, and then the driving direction.

The speed range can be changed while driving. Downshifting should not take place until the speed of the machine is below the max. speed in the next lower gear.



Shift forward/reverse cannot take place until the machine is standing still!

### Manual gearshift:

If the switch for automatics 4 (fig.20) is put in non-activated position, the machine will remain in the chosen speed range (1st to 4th gear).

If the switch for automatics is put in activated position, the machine will shift to automatic mode when or if the position 4A is chosen.

If you want to drive in 5th or 6th gear manually, choose automatic mode, whereafter the required gear can be locked.

### Automatic gearshift:

If the switch for automatics is put in activated position and the gear selector is put in 4th gear and then in forward or reverse, the machine will drive in automatic mode.

The machine will then start in the 2nd gear forward or 1st gear reverse, whereafter it will always choose the optimum speed range. The range is chosen from current speed, load and engine revolution.

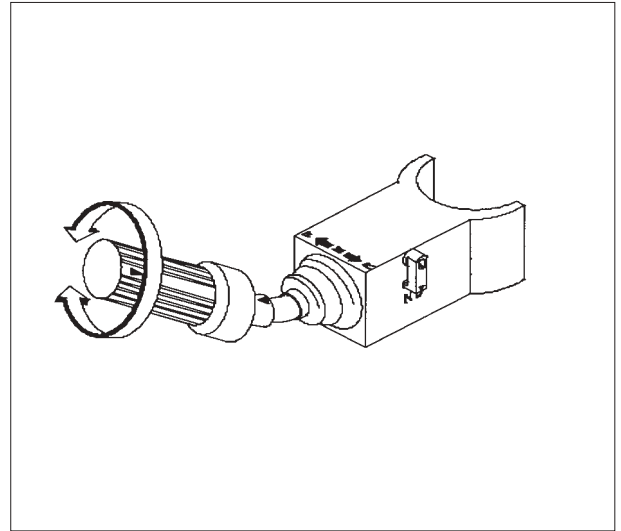

Fig. 25

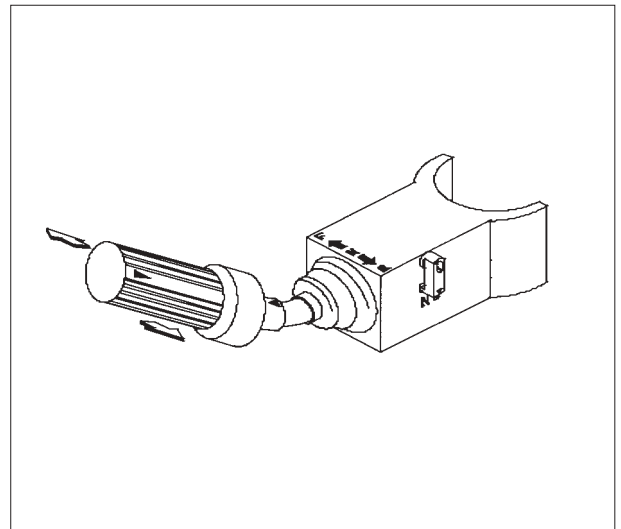

Fig. 26

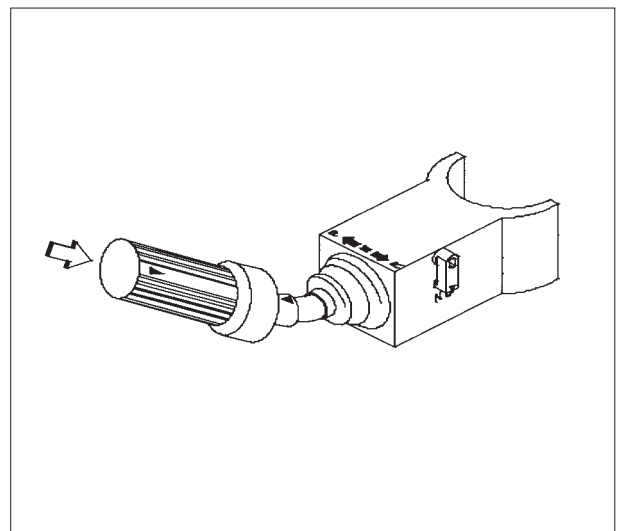

Fig. 27

It is possible to lock any gear by pushing the end of the gear selector. Another push releases the gear and the automatic mode is activated again. The current gear is shown in the display 1, fig. 28.

**IMPORTANT!**

Always select a suitable gear for the task. Continuous driving in too high a gear can result in too high temperatures.

**IMPORTANT!**

Never let the machine drive downhill with the gear selector in neutral, as this can damage the transmission.



Always start with low engine revolutions. High engine revolutions cause starting with a jerk which can be dangerous.

Gear chart for automatic mode position:

Gear selector position	Speed range	Display forward	Display backw.
1	0 - 6	1 F	1 R
2	0 - 9	2 F	–
3	0 - 13	3 F	2 R
4 A	0 - 20	4 F	–
5	0 - 29	5 F	3 R
6	0 - 43	6 F	–

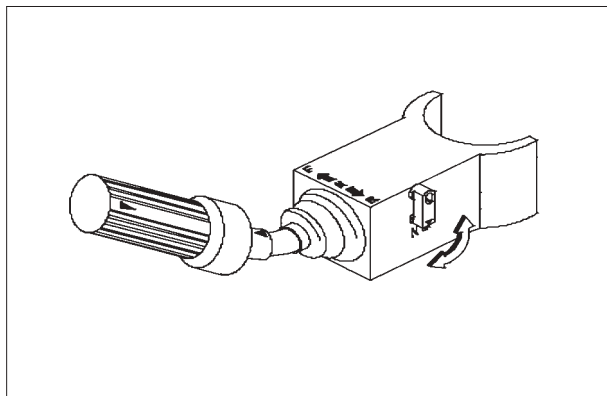

Fig. 29

**Locking:**

The gear selector can be locked by turning the knob (fig. 29). The gear selector should always be locked when you leave the machine.

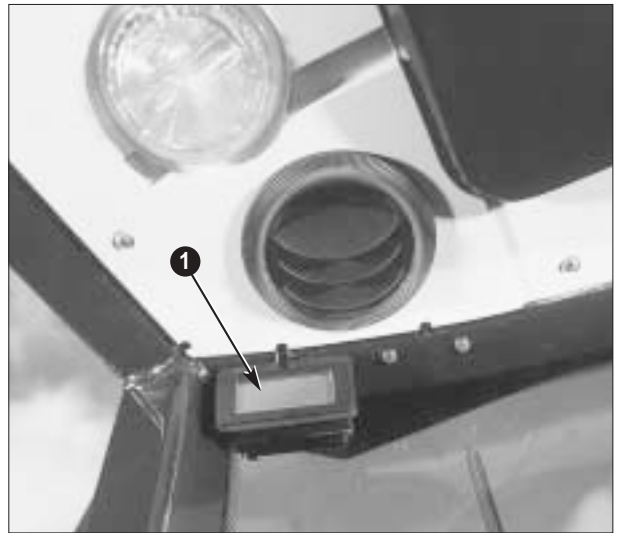
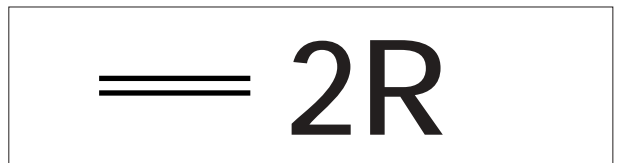

Fig. 28

**Display:**



shows the gear selector in neutral position.



shows 2<sup>nd</sup> reverse, manual



shows 4<sup>th</sup> gear forwards, automatic mode

**Fault reports**



shows that the gear selector is not in neutral position.

Other fault reports in the display may appear, if the gear system is faulty. Contact the Hydrema Service then.

## DRIVING

### Marking of the machine:

When driving on public roads the warning triangle must be mounted. (obligatory in some countries only).

### Running-in the engine:

Being new the machine should be driven carefully for the first 50 hours. Drive slowly until you have made yourself familiar with the machine. However, the new engine is capable of full performance from the beginning, provided that it has reached a working temperature of min. 60°C.

### IMPORTANT!

Check frequently oil level and temperatures.

## SAFETY WHEN DRIVING



Before driving check that the machine is clean so lamps and signal equipment can function.

Always adapt the speed to the conditions and never drive at a higher speed downhill than the normal driving speed of the machine.



It is deadly dangerous to stop the engine during driving as the steering capability is considerably reduced.



If the red lamp for the steering pump, pos. 3 (fig. 21) lights during driving, stop the machine at once.



Never drive with the machine, while the dumper body is tipped. It reduces the stability and view.



If the acoustic alarm sounds during driving stop the machine at once. It is for example deadly dangerous to drive with insufficient brake pressure.

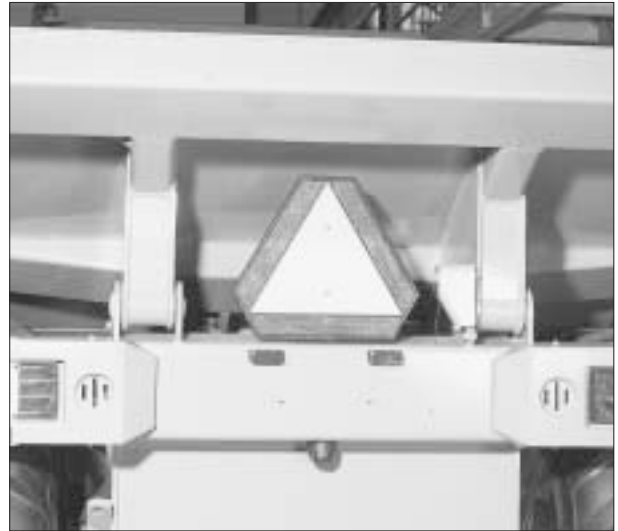

Fig. 30

### Driving in general:

Keep an eye on other persons being near the machine. Avoid sudden application of the brakes. Always adapt the speed to conditions. Always select a gear suitable for the job.

### Loading of material:



Never drive with excessive loads. The operator is responsible for the machine being properly loaded.

The max. carrying capacity is 10 tons. This capacity results from materials with a density of 1800 kg per m<sup>3</sup> loaded to the upper edge of the dumper body, and a heaped gradient of 2:1. If the material is heavier, the dumper body must not be completely filled.

For your guidance see the density chart on page 36 for various materials.



**Driving in terrain:**

Before driving in terrain check that driving is safe and where the conditions are best.

**Driving in soft terrain:**

The machine is equipped with limited slip differential lock on the rear axle which automatically transfers up to 50% of the tractive forces to the least loaded wheel.

**Driving on gradients:**

$\alpha$  = angle of gradients where the machine is rolling over.

**Unloaded:**

- Driving straight ahead = 40°
- Turning upgrade = 39°
- Turning downgrade = 41°

**Loaded:**

- Driving straight ahead = 32°
- Turning upgrade = 29°
- Turning downgrade = 34°

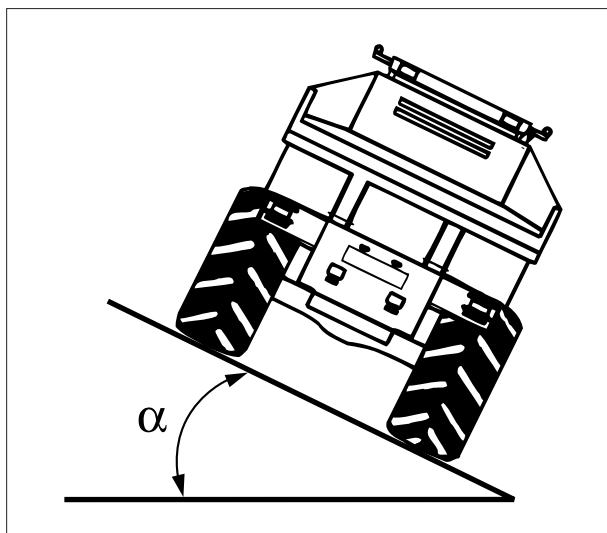

Fig. 31



Never drive on slopes as large as the rollover angle. Pay special attention to this when the terrain is uneven.

**Driving on slopes**

Speed km/h with max. load:

Gear \ Gradient	10%	20%	30%	40%
1 <sup>st</sup>	5,5	5	4	4
2 <sup>nd</sup>	8	5,5	3	
3 <sup>rd</sup>	10	3,5		
4 <sup>th</sup>	8			

Driving should as far as possible always take place parallel to the slopes.

**Unloading of material:**



Do not reverse near slopes. Pay attention to the fact that the rear axle load is increasing when the load is tipped, especially when the material does not slip easily, or if there is the risk that the material is frozen up.

Place the machine in non-articulated position before the tipping is started.

Make sure there is enough room upwards when the dumper body is tipping. The max. height when raised is 4.22 m.

**Driving on public roads:**

Make sure that rules and regulations for driving the machine are observed.

Make sure that the machine fulfills the safety regulations and the lamp glasses are clean.

Always pay attention to other road users, especially those coming from behind. When driving with loads make sure that the material is loaded in a way that spill is avoided.

**Stopping the machine:**

- reduce the engine revolutions
- activate the brake
- put the gear selector in neutral
- activate the parking brake
- when stopping the engine turn the key counter-clockwise into position 0



**Material density chart:**

<b>Material</b>	<b>kg/m<sup>3</sup> in bulk</b>	<b>kg/m<sup>3</sup> compact</b>
Basalt	1960	2970
Granite, broken	1660	2730
Gravel:                      dry 6-50 mm wet 6-50 mm	1690 2020	1900 2260
Earth:                        dry, packed wet, excavated	1510 1600	1900 2020
Coal                           raw	1190	1600
Stone, crushed: 75% stone, 25% earth 50% stone, 50% earth 25% stone, 75% earth	1960 1720 1570	2790 2280 1960
Lime	1540	2610
Clay:                         dry wet	1480 1660	1840 2080
Clay and gravel:           dry wet	1420 1540	1660 1840
Humus	950	1370
Sand:                         dry wet	1420 1840	1600 2080
Sand & clayr:               dry wet	1600	2020 2400
Sand & gravel:             dry wet	1720 2020	1930 2230
Slag, broken	1750	2940
Stone, crushed	1600	2670

**TOWING**

Towing must only take place in exceptional cases. A towing bar mounted in the towing eye at the front of the machine must be used (fig. 32).

Never tow on public roads or with loads. The machine must be properly marked.

**Towing with dead engine:**

Before towing can be started, the parking brake must be deactivated, as there is no hydraulic pressure to keep the brake deactivated. To deactivate, the six screws in the front axle have to be tightened (3 on each side), (fig. 33 and 34) until the bottom position is reached. Use an 8 mm Allen key from the tool box.

When towing the speed must not exceed 10 km/h, and the distance must not be longer than 10 km. Towing at longer distance may damage the transmission because its oil pump is not running.

When towing at a longer distance or at a speed higher than 10 km/h, both front and rear cardan shaft must be demounted.



Service brake and steering mechanism do not work when towing with a dead engine.

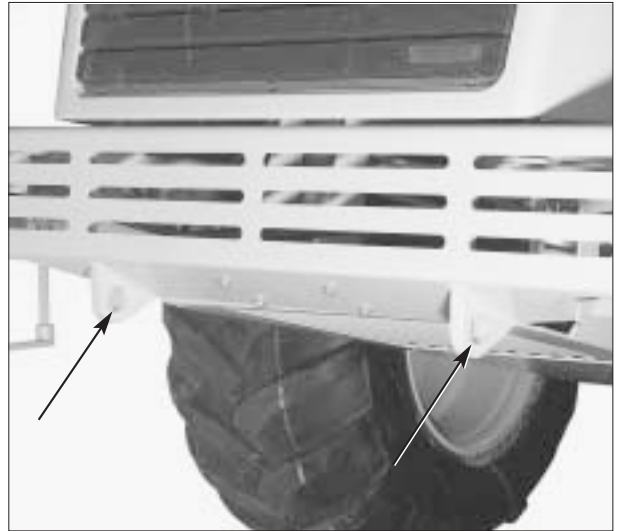

Fig. 32

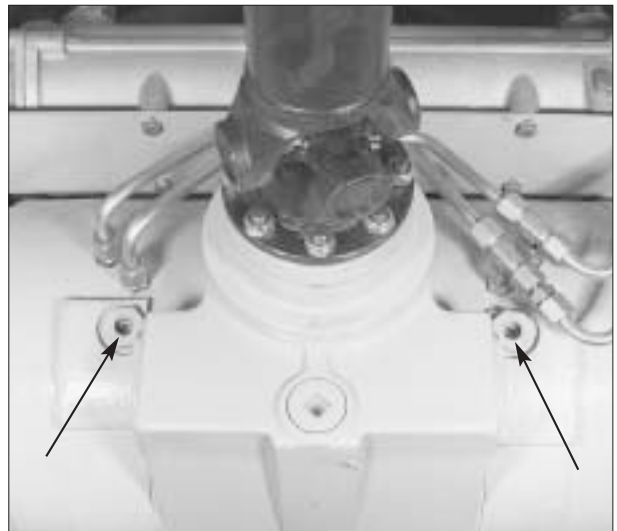

Fig. 33



Fig. 34

## TRANSPORT

Transport on a trailer

Check the type and dimensions of the trailer in relation to the machine which is to be transported.

Dimensions of the machine:

Length:	5,90 m
Height:	2,66 m
Width:	2,50 m (over tyres 600/55-26.5)
Unladen weight:	6500 kg / 6950 kg for multi-tip

1. Drive carefully the machine up on the trailer. Stop the engine and activate the parking brake.
2. Mount the pivot lock Fig. 45 and safety bolt 1, Fig. 42.
3. Place stop blocks in front of the front weels and behind the rear wheels.
4. Tighten the machine to the trailer with chains in the towing eyes in front fig. 32 and the axle plates at the rear fig. 35.
5. Check that the distance from the ground to the max. height of the machine does not exceed the permissible transport height.



It might be deadly dangerous to transport the machine if it is not properly fastened to the trailer.



### Lifting the machine:

If the machine is lifted by a crane, 4 lifting belts must be used, each of a length of min. 4 meters. Mount them in the lifting eyes with clevises.

The machine's nett weight: 6500 kg/ 6950 kg

Provided that the lifting belts are four meters, the specifications are as follows:

Load of front lifting belt: 2180 kg each

Load of rear lifting belt: 2260 kg each

Lifting point: approx. 4.6 m above ground



Fig. 35

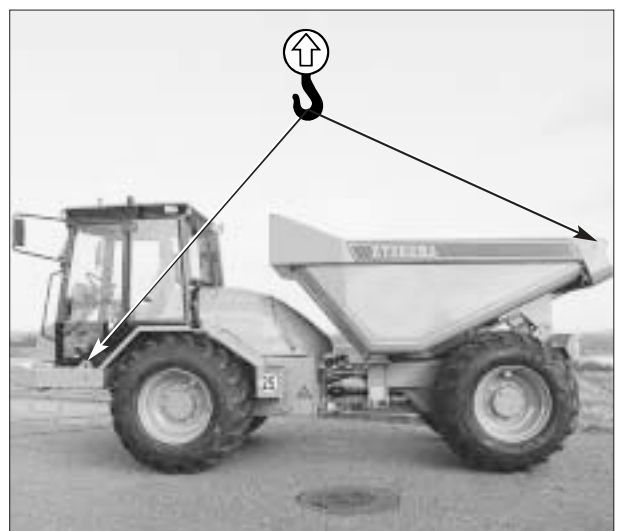

Fig. 36

**SPECIAL CONDITIONS**

**In cold weather:**

In winter or when the temperature falls below the freezing point do not forget the following:

- Fill anti-freeze into the cooling system.
- Use thinner lubricating oil.
- Fill up the fuel tank when having finished work in order to avoid condensed water in the tank.
- Having started the engine, run the machine at low speed and small load until the oil in engine, transmission, hydraulic system and axles is warmed so much that it is thin enough to lubricate correctly.

Do not use the machine for tough work right after the start, when it is freezing hard.

**Starting in cold weather:**

If the machine cannot be started due to lack of battery capacity, an auxiliary battery can be connected.

**Starting with auxiliary battery:**

- Dismount the cover of the battery box.
- Check that the battery has a voltage of 12V.
- Connect one end of the jump leads to the positive pole on the battery of the machine. Take care that the jump lead battery terminal does not touch the frame.
- Connect the other end of the jump leads to the positive pole of the auxiliary battery.
- Connect one end of the other jump lead to the negative pole of the auxiliary battery, and the other end to the chassis of the machine - away from the battery. It may for example be connected to the step or direct to the engine block at the mounting bolt of the starter motor.

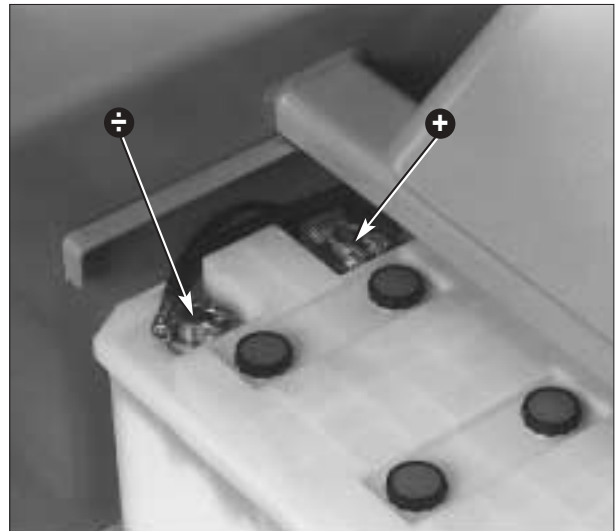

Fig. 38

**IMPORTANT!**

Reverse polarity may damage the voltage relay and the alternator. Repeat the procedure 'Starting a cold engine'.



The engine may only be started from the operator's seat. Attempts to start the machine by short-circuiting puts the start lock of the machine out of action which may cause accidents.



**Danger of explosion!**

Due to voltage drop the battery may explode if a fully charged battery is connected to an entirely or partly discharged battery. Avoid sparks and open fire close to the battery.



**Danger of corrosion!**

The battery electrolyte contains corrosive sulphuric acid! Avoid direct contact!

**IMPORTANT!**

When the machine is starting

- Check that the pilot lamps are out.
- Take away the jump leads between chassis and negative pole of the auxiliary battery.
- Take away the jump leads between positive poles.  
Never take away the fastened cables for the standard battery. It may damage the alternator.

**Ether type fuels**

The engine can be started with manually operated pilot if fitted.



Ether type fuels must not be used at the same time as the preheater.

**In warm weather:**

Even when it is warm, it is important to drive with the correct oil, see lubrication chart (page 61).

Clean the engine air filter more often (page 48) and keep the radiator clean (page 50).

Also make sure that the engine and transmission are kept clean, as dirt has an insulating effect.

**Water and mud:**

Driving in water and mud must only take place in short periods if the wading depth does not exceed 700 mm. After driving in water and mud clean the machine. If the mud is left to dry it may cause damage to components like cardan shafts. Lubricate the machine after cleaning.

**OUT OF SERVICE - STORAGE**

If the machine should be out of use for up to three months take care of the following:

1. Park the machine indoor. If this is not possible, park the machine on boards in a dry, covered place. Mount the lock on the stabilizers.
2. Wash the machine.
3. Release the pressure from the hydraulic system by operating lever forwards and backwards a couple of times, and by activating the brake pedal 20 to 30 times. Loosen the filler cap of the hydraulic tank to release pressure in tank.
4. Apply paint where surface is not intact.
5. Grease all nipples
6. Fill up fuel tank
7. Apply anti-rust composition, for instance Tectyl, to all visible piston rods.
8. Drain coolant or apply anti-rust composition. Check coolant freezing point.
9. The battery must be fully charged.

**After max. 3 months start the machine in the following way:**

1. Drain fuel tank and water separator.
2. Drain hydraulic oil tank.
3. Clean piston rods with kerosine for instance.
4. Fill with coolant or check coolant level.
5. Check engine and transmission oil level.
6. Check alternator belt.
7. Start engine as described on page 31.
8. Run the engine until working temperature is reached.

**If the machine has to be stored for more than three months, please contact HYDREMA service department for further information as to long-term storage.**

**EQUIPMENT**

**Multi-tip function:**

For machines with multi-tip function it is possible to place the unloaded material direct behind the machine or anywhere between 90° to the right or left side.

**Unloading to one side:**



See 'Unloading of material' page 35.

Before you lift the dumper body the machine should be placed in straight position on a horizontal even surface.

Before the dumper body can be turned, the body must be lifted until the instrument display indicates DUMPER BODY LIFTED so that it can be turned free of stopper and wheels.

The lever is moved to the side where the material is to be unloaded (Fig. 40).

When you lower the dumper body again, it must be turned to center position before it can be lowered completely. If it is lowered before it is turned, it may be necessary to raise it slightly so that it can be turned and lowered again.



The dumper body must not be raised or turned during transport on public roads. Driving in terrain with a turned dumper body must only take place with a speed of max. 5 km/h.

Make sure there is free space around the machine and no persons near by before turning the dumper body.

Loading height:	2320 mm
Total height when tipping:	4450 mm
Unloading over tyres:	500 mm



Fig. 39

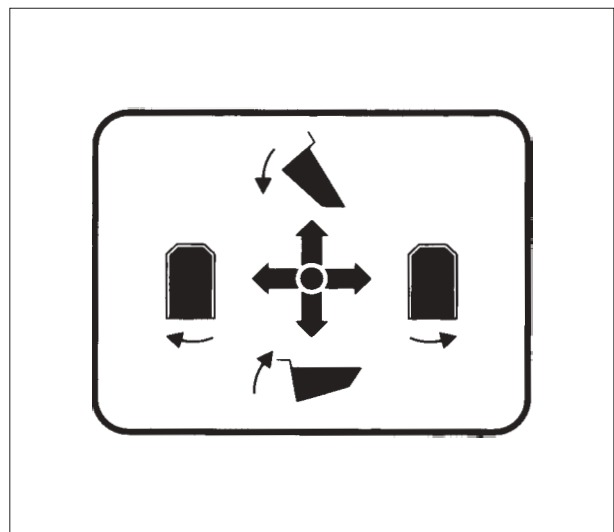

Fig. 40

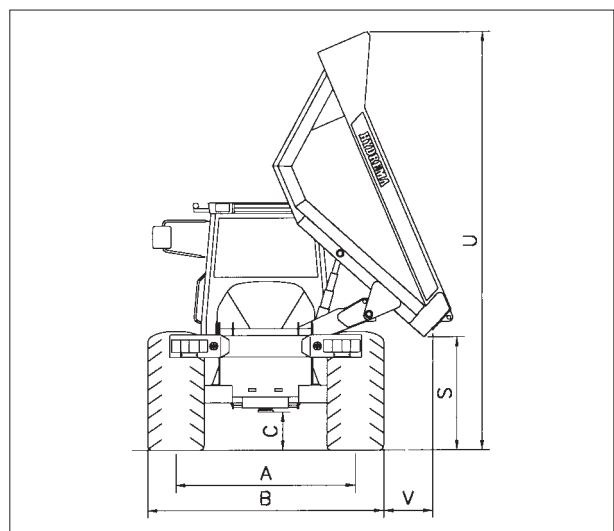

Fig. 41

If you do not want to use the multi-tip function, the turning movement can be blocked by fitting the safety bolt 1 fig. 42.



Always mount the safety bolt when driving on public roads or when towing on a trailer.

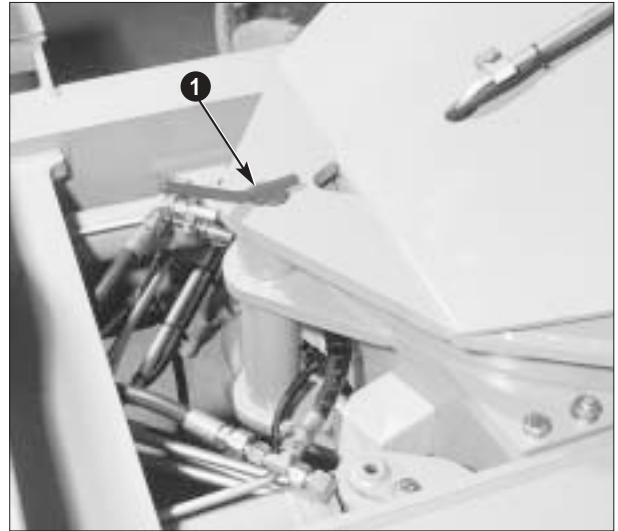

Fig. 42

#### Towing device:

The fork type towing hook is not standard fitted and is not approved for trailers but intended to be used for towing and shunting. The 7-poled trailer plug is standard fitted.

The towing device is placed 675 mm above ground.

The diameter of the towing bolt is 31 mm.

The towing device may be loaded up to the max. tractive effort of the machine, but must not be loaded vertically. If the towing device is used for salvaging the machine, it may be loaded with a max. tractive effort of 10 tons.

#### NOTE:

Other types of towing hooks may be mounted. When mounting other types, their specifications must be observed.



Fig. 43



## LUBRICATION IN GENERAL

### Safety:

Before lubrication and maintenance start take care that

- the machine is placed on a plane surface
- the gear selector is in neutral and locked
- the parking brake is activated
- the ignition key is removed -unless the transmission oil level has to be checked.
- the pivot safety lock is mounted fig.45
- the support device fig.46 is mounted or, if multi-tip, the safety bolts on both sides fig. 47 and the safety bolt fig.42 for turning are mounted.



Never walk under a lifted dumper body until the support device is mounted.



Hot oil may cause scalds. Avoid direct contact.



Never use open fire near the fuel tank.



Wear safety mask or goggles when cleaning with compressed air or high pressure cleaner.



Fig. 45

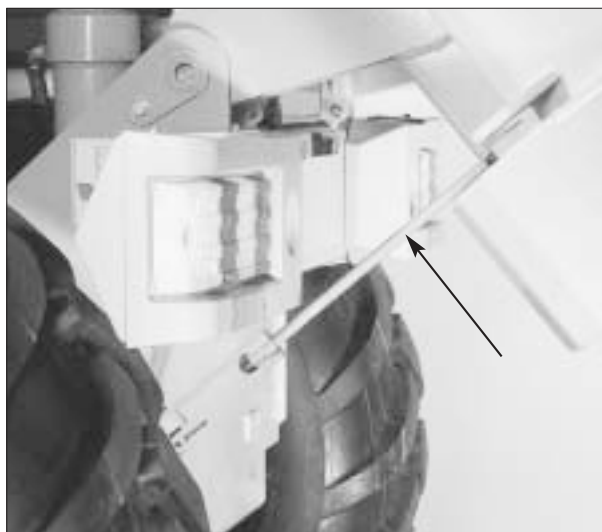

Fig. 46

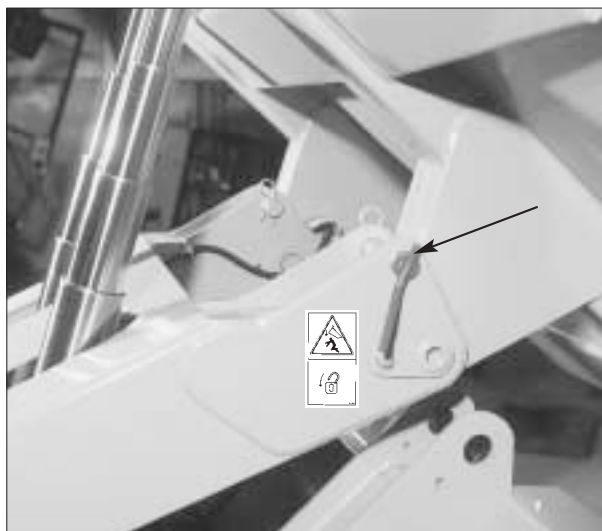

Fig. 47



**Greasing in general:**

Grease until the old grease appears.

**IMPORTANT!**

Observe the lubrication intervals as stated in the instrument display and the lubrication chart (page 63).

**Bonnet:**

The daily inspection, for example check of liquid level, can be made through the open bonnet fig. 49.

For further service it is possible to dismount the bonnet.

**Dismounting the bonnet:**

In order to dismount the bonnet fig.50 the dumper body must be raised, the rear window grill removed and the two break-in safety devices 1 fig.50 removed on both sides. It is now possible to dismount the bonnet by pulling it out of the four rubber plugs on which it is mounted.

If the rubber plugs on bonnet and rear window grill are difficult to remove, lubricate the plugs with grease or hydraulic oil.



Fig. 49

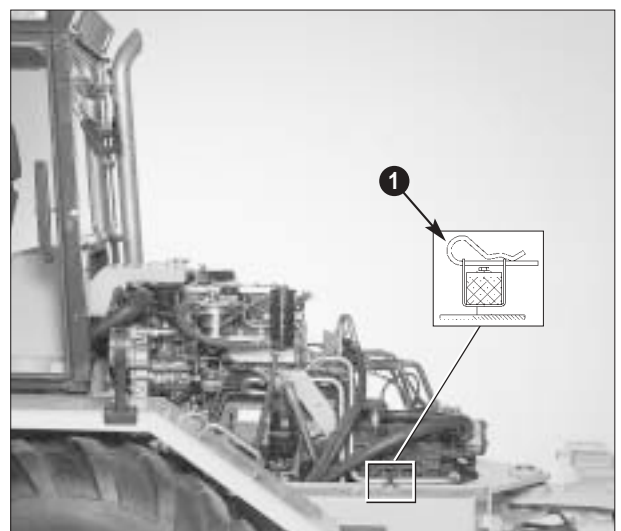

Fig. 50

 **ENGINE:**

 **Engine oil level:**  
(every 10 hours)

Check engine oil level with the dipstick 1.  
The oil level must be between min. and max.  
mark.

 **Engine oil change:**  
(every 400 hours)

Stop engine when it has reached the normal  
working temperature. Unscrew plug 1 fig. 52  
and place a draining container under the  
engine. When you screw on the hose with the  
angular adapter from the tool set, open the  
valve and drain the oil through the hose.

 **Oil filling:**

Fill engine with the specified oil (page 61)  
through the filler plug 1 fig. 51 to the top mark  
of the dipstick 1 fig. 51.

 **Engine oil filter:**  
(every 400 hours, at oil change)

When changing the filter the whole unit must  
be replaced. Unscrew oil filter 2 fig. 52  
and discard it. Fill the new filter with oil, coat its  
seal ring with a thin layer of oil and mount it.  
Do not tighten too hard.

**IMPORTANT!**

A turbo-charged engine must have correct oil  
pressure right after start. To ensure this after  
the oil filter change proceed as follows:

Demount the wire at the stop valve 1 fig. 53 of  
the fuel pump.  
Activate the starter til the oil pilot lamp is out.  
Remount the wire onto the stop valve and  
start the engine. Check the filter for leaks.  
Stop the engine and check the oil level.



Fig. 51

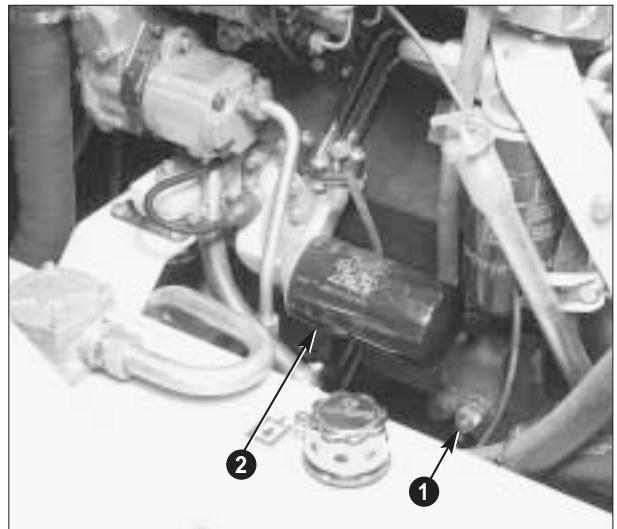

Fig. 52



Fig. 53

## FUEL SYSTEM

The fuel tank is placed on the right side of the front frame.

Always fill with clean, high-quality diesel oil.  
Filler cap 1 fig. 55.

**Draining:**  
(every 400 hours)

Drain through cap 1 fig. 54, while the machine is placed so that the cap is the lowest point.  
The tank should not be full.

**Water separator:**  
(every 200 hours)



Drain any water and sediment through the bottom screw 2 fig. 55.

**Lift pump:**  
(every 400 hours)



Remove cover 1 and clean the sieve carefully for dirt and sediment. Clean cover and seal. Assemble lift pump.



Fuel under pressure may penetrate the skin and cause serious injury.



Diesel fuel is inflammable. Keep open fire away from the machine and avoid smoking when working with the fuel system.

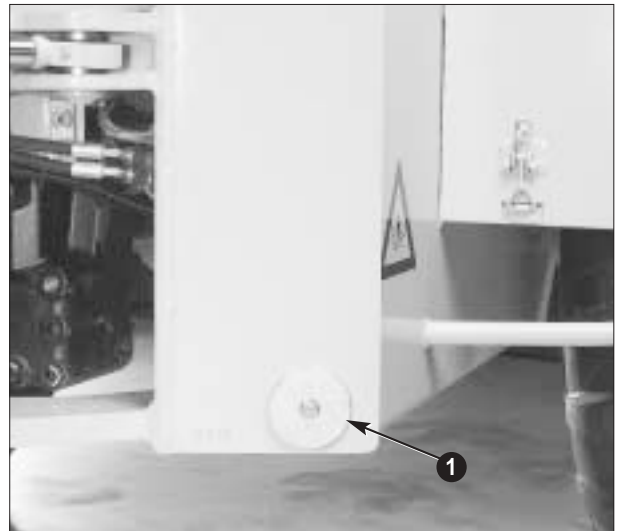

Fig. 54

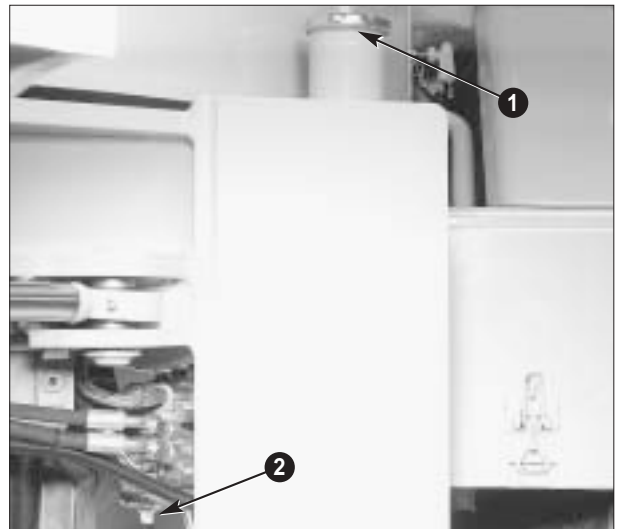

Fig. 55

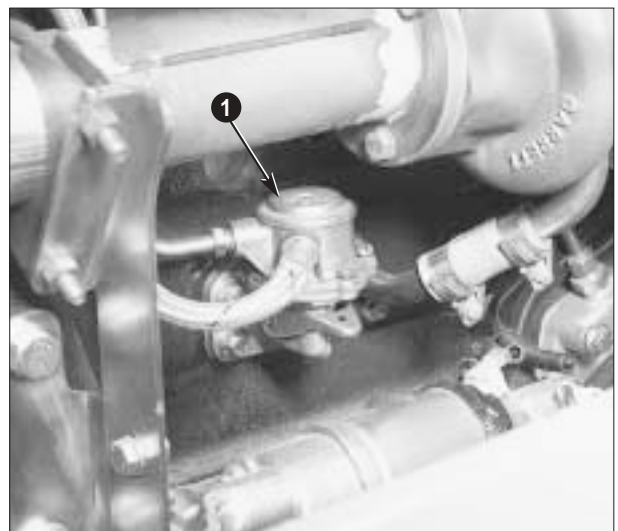

Fig. 56



**Replacement of fuel filter:**  
(every 400 hours)

First, clean outer side of the filter unit and then drain fuel from filter, screw 1.  
When changing the filter demount the whole filter element and replace it.  
Check that the threaded portion of the filter head is fixed and the filter head is clean.  
Coat the 2 seal rings of the new filter with diesel oil and mount it. Do not tighten too hard.

**Bleeding of the fuel system:**

When the fuel filter has been replaced or if the machine has been run dry of fuel, it is necessary to bleed the system:

1. Loosen the pipe to the preheating nozzle 1 fig. 58.
2. Slowly activate the pump piston 1 fig. 59 on the lift pump until fuel without air runs out at the preheating nozzle. Gently tighten the pipe again.
3. Loosen nozzle pipes of two nozzles.
4. Make a start attempt by turning the ignition key until the fuel runs out at the nozzle pipes.
5. Gently tighten the nozzle pipes and start the engine.

**NOTE:**

If the camshaft is at its highest point, it is not possible to activate the lift pump piston. Therefore rotate the engine approx. one turn.

Clean the system and check for leaks.

If the engine runs satisfactorily for a while after bleeding and then becomes irregular or stops, it is probably due to a leak on the suction side of the system.

**Self-bleeding system:**

The engine is equipped with a self-bleeding system, which means small air pockets in the system are automatically bled.

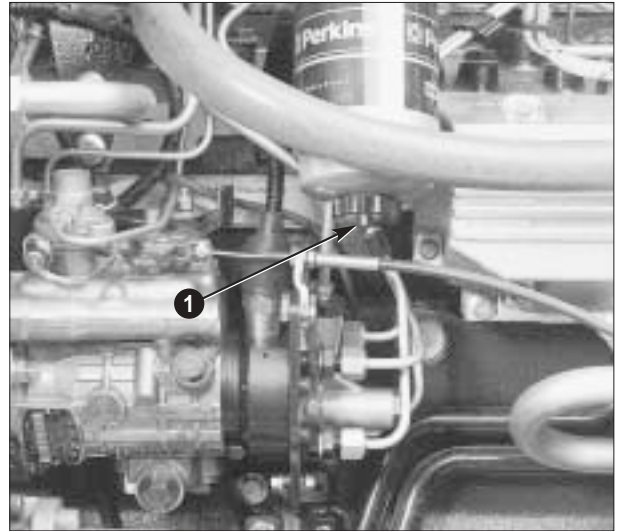

Fig. 57

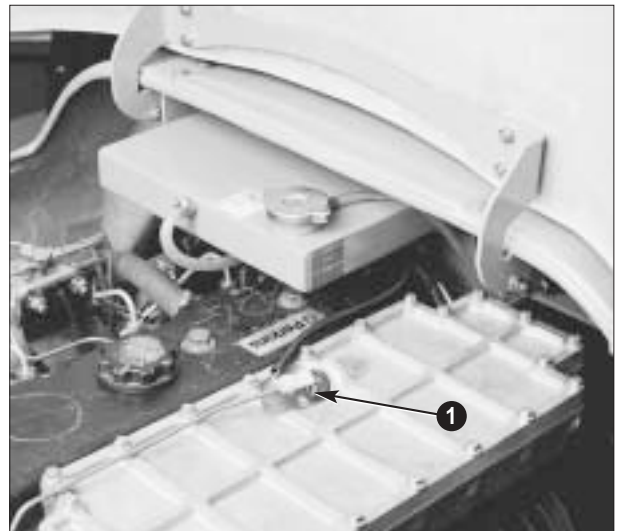

Fig. 58

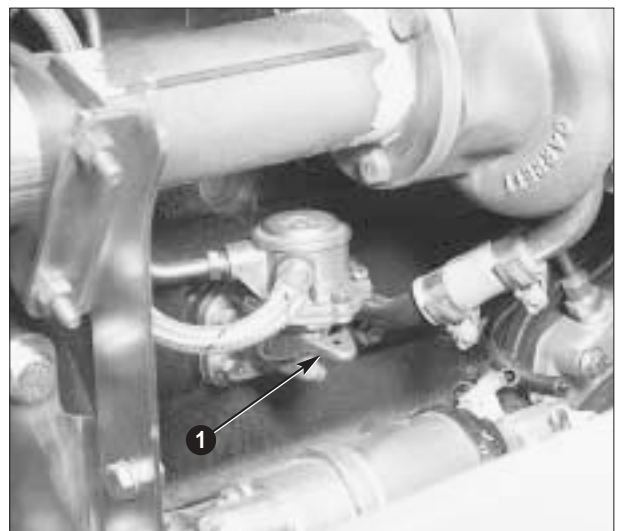

Fig. 59



## AIR FILTER (every 200 hours)

When the air filter pilot lamp lights, or every 200 hours, the air filter 3 must be cleaned or, if necessary, replaced.

The main filter must be replaced every 400 hours.

Clean the cyclone when necessary.

The working conditions are an important factor when deciding how frequently it is necessary to check and clean the air filter.

1. Filter housing
2. Safety filter
3. Main filter
4. Cover
5. Cyclone

### Main filter:

Remove the cover and the main filter from the housing. The element is cleaned in the following way:

If the filter element is fouled by dry dust, clean by using compressed air directed from inside the element.



Use face mask or goggles when cleaning with compressed air. The pressure must not exceed 205 kPa (2 bar). Higher pressure may damage the filter.

If the filter element is fouled with oil, it may be washed in a nonfoaming detergent for about 10 minutes. Move the element in the detergent to remove loosened particles. Clean element with water from inside and let it dry.

Use a lamp to check for small tears, rips or other damage. If the filter is faultless, it may be refitted, but if it is damaged it has to be changed.

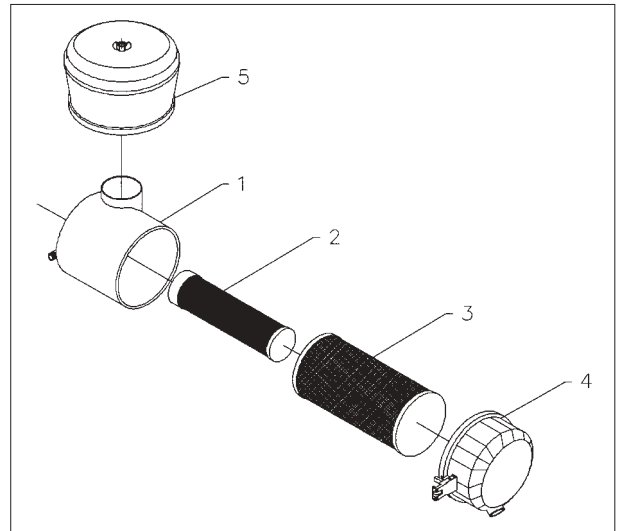

Fig. 60

### Safety filter:

The safety filter 2 functions as an extra filter in case of a damaged main filter. If the main filter is damaged and the safety filter clogged, or the pilot lamp lights after the replacement (or cleaning) of the main filter, a new safety filter must be mounted (never clean a safety filter).

### Discharge valve:

On the air filter housing cover 4 a rubber discharge valve is fitted, which is automatically emptied when the engine idles. The arrow on the cover 4 must point upwards.

### NOTE:

Never try to clean the filter by hitting it against a hard surface.

### IMPORTANT!

Never remount a filter element with damaged wrinkles or junctions between filter and bottom.

Never install a wet filter.

Always take care that new or cleaned filter elements are available.





**COOLING SYSTEM**

The cooling system is a sealed system with an expansion tank.

The cooling system is equipped with an oil cooler for the transmission oil. It is positioned between radiator and engine.



The cooling system is working under pressure. Therefore it is dangerous to remove the cover 1 while the system is hot. Always turn the cover carefully to allow for release of pressure. Only remove the cover after excessive fluid has disappeared.

The coolant may cause skin irritation.



**Coolant level:**  
(every 10 hours)

Check the coolant level in the plastic hose 2 fig. 61.

The level must be between the min. and max. mark., and not under the bottom of the expansion tank when the engine is cold.

On delivery a corrosion inhibitor is added to the anti-freeze agent, so it may be used throughout the year.

At temperatures below freezing point anti-freeze liquid should be used, mixed as shown below

**% volume:**

ANTI-FREEZE	FREEZING POINT
10%	- 4°
20%	- 9°
30%	-15°
40%	-22°
50%	-35°

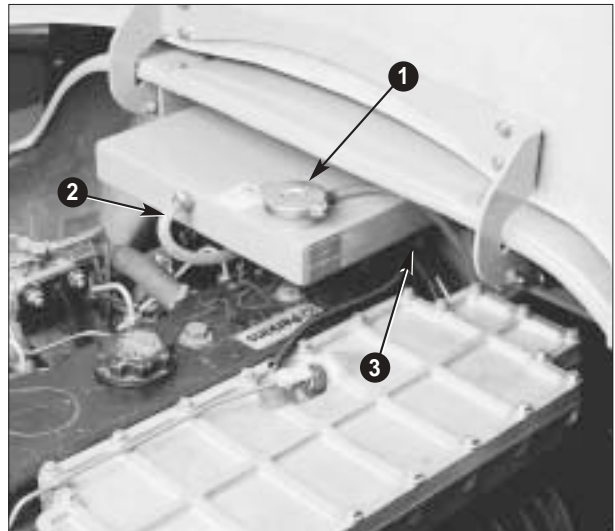

Fig. 61



Fig. 62

**Coolant draining:**

Loosen the cover and the tap at the bottom of the radiator fig.62 (seen from below). Remove the screws 3 fig.61 and 1 fig.63 to ensure that the intercooler and the engine block are completely emptied.

**Filling of coolant:**

Make sure that the tap and plugs fig. 61 and 63 are mounted. Fill mixed coolant through the cover 1 fig.61 to the max. mark.

1. Loosen the drain plug 3 fig. 61 until coolant without air runs out.
2. Check the fluid level and start the engine with the tap open to the heating system, speed up the engine to 2000 rpm and keep filling with mixed fluid. Put on the cover when the system has been filled to the max. mark.
3. Loosen the release screw 3 fig. 61 to check that the coolant is free of air to the intercooler.
4. Run the engine until warm and check level. Replenish if necessary.

Capacity: approx. 36 litres

**Cleaning of radiator:**

(every 50 hours or when required)



Stop the engine and remove the ignition key.

The radiator is placed behind the cabin.

The radiator must be cleaned with a soft brush. Open the belly plate and clean from beneath and through the hatch fig .64.



Use dust mask.

Having brushed off the dry dirt clean the radiator with compressed air from the engine side.



Fig. 63



Fig. 64

## TRANSMISSION

 **Gear box oil level:**  
(every 10 hours)

Check the oil level when the oil is hot. When the oil has been heated to working temperature, the engine must run idle for approx. 2 min. With the gear selector in neutral position, check that the oil level is between the two upper marks on the dipstick 1 fig. 65. The lower mark is used for checking when the oil is cold and is only intended as a guidance.

 **Oil change:**  
(every 1000 hours or once a year)



Warm oil may cause severe scalds. Use gloves when checking warm oil and make sure that you can drain safely.

When the engine has been turned off for 5 min. after the oil had had working temperature, unscrew the drain plug 1. Refit the plug and fill with specified oil (page 61) through the pipe 1 fig. 65.

Capacity: approx. 12 litres

 **Filter change:**  
(every 1000 hours)

Replace the transmission filter 1 fig. 67 at every oil change. Dismount the filter and discard it. Clean the filter head and lubricate the seal ring of the new filter with oil and fill the filter with oil before mounting it. Do not tighten too hard. Check for leaks.



Fig. 65



Fig. 66

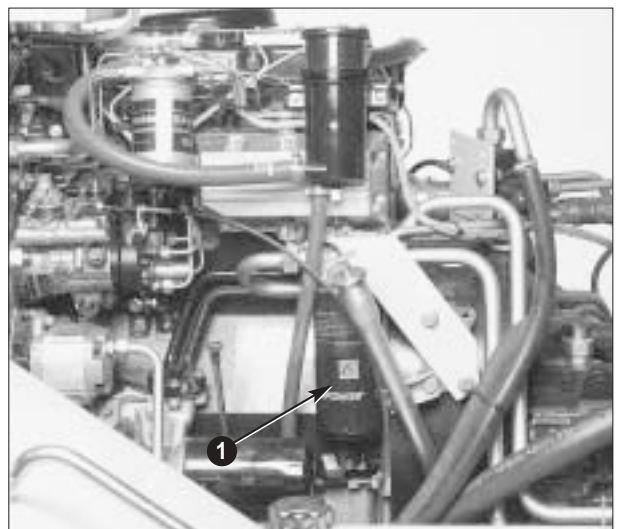

Fig. 67



**AXLES**

**Differential  
Oil level:**  
(every 200 hours)

Check the oil level by removing level and filler plug 1 fig. 68.



**Oil change:**  
(every 1000 hours or once a year)



Warm oil may cause severe scalds.  
Use gloves when checking warm oil and make sure you can drain safely.

Unscrew plug 1 fig. 69 and drain oil. Refit the plug and fill with the specified oil in filler plug 1 fig. 68.

(Oil specification, see page 61)  
Capacity: approx. 14 litres



**Wheel hub  
Oil level:**  
(every 200 hours)

Turn wheel hub so the arrow 'Oil level' is horizontal. Dismount the filler plug 1 fig. 70 and check that the oil level reaches the arrow 'Oil level'.



**Oil change:**  
(every 1000 hours or once a year)



Warm oil may cause severe scalds.  
Use gloves when checking warm oil and make sure you can drain safely.

Turn the wheel hub until the plug 1 fig. 70 points downwards. Unscrew the plug and let the oil run out. Turn the wheel hub until the arrow 'Oil level' is horizontal. Fill the specified oil (page 61) until the level is reached.

Capacity: 1,3 litres per hub

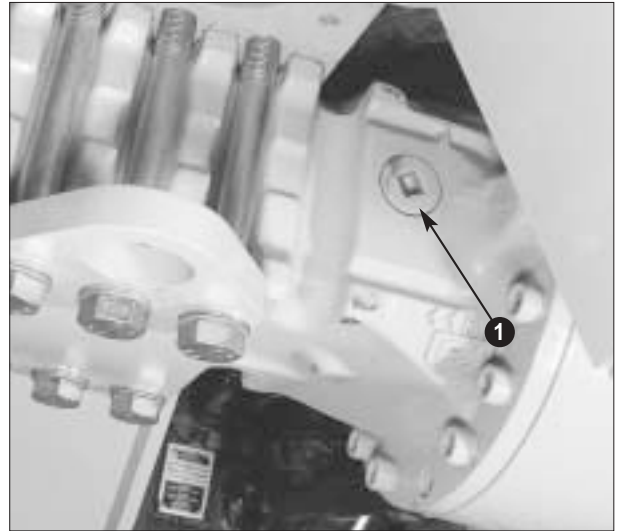

Fig. 68

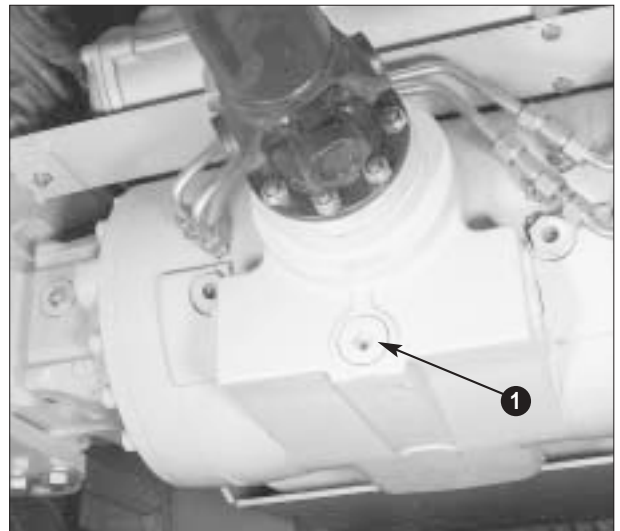

Fig. 69

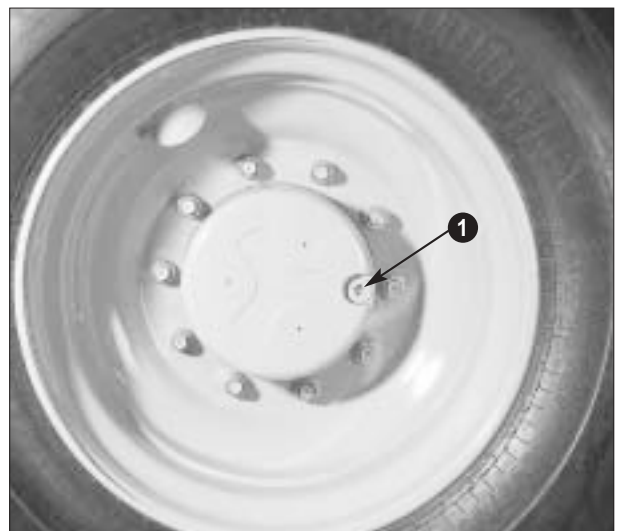

Fig. 70

## (○) BRAKES

The service brake is a dual-circuit and fully hydraulic self-adjusting brake. If the brake performance is not at optimum, contact immediately Hydrema Service.

The angle of the brake pedal can be adjusted with screw 1.

## (P) Parking brake:

The parking brake functions as a spring loaded system that works on the brake discs of the service brake in the front axle.

If the parking brake 1 fig. 72 is not activated, the hydraulic pressure is let in to keep the spring loaded brake free.

Be aware that the parking brake is totally free when the switch is not activated.

When the switch is activated, the locked in oil is released and the spring loaded brake activated.

If the parking brake is not at optimum, contact immediately Hydrema Service.

For mechanical release see 'towing with a dead engine' page 37.

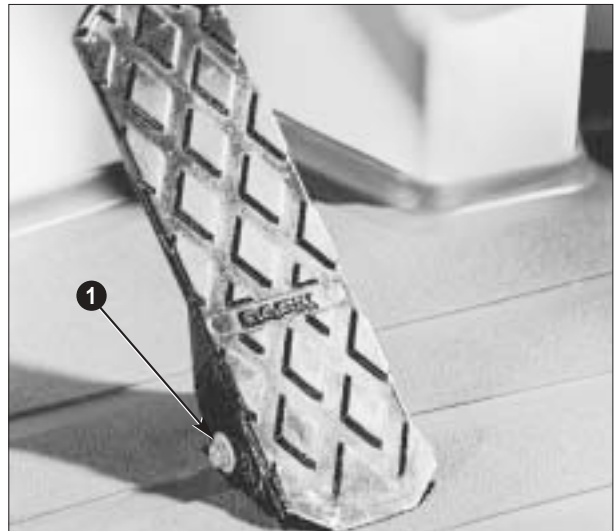

Fig. 71

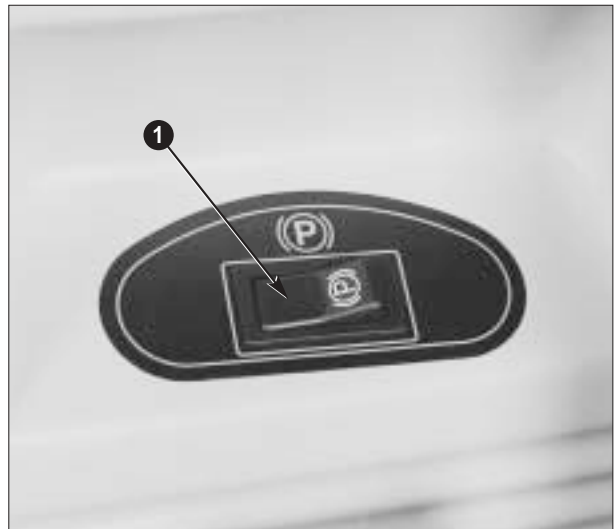

Fig. 72

## ELECTRICAL SYSTEM



**Alternator:**  
(every 200 hours)

Check condition and tension of the alternator belt. A correctly adjusted belt can be pressed 10-15 mm down between the pulleys at a pressure of approx. 10 kg.

To adjust the belt loosen alternator mounting bolts 1, 2 and 3.  
Move the alternator away from the engine to obtain correct belt tension. Retighten mounting bolts.

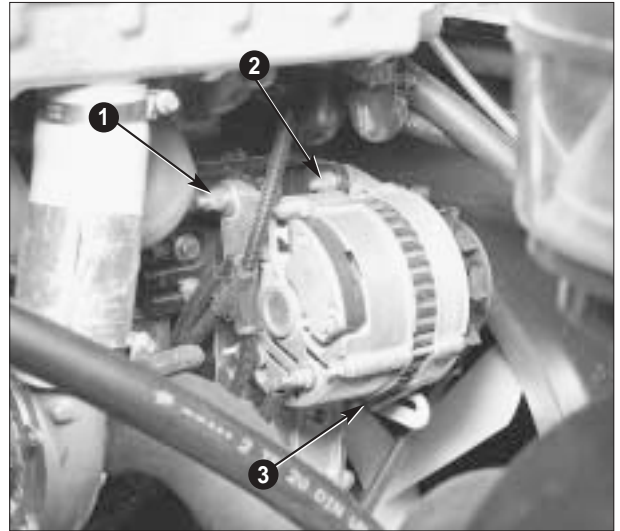

Fig. 73



**Battery:**  
(every 200 hours)

The battery is placed in the battery box behind the right front wing. Check the electrolyte level which has to be 5-10 mm above the elements. If the level is too low, replenish with distilled water. Do not check the level when the engine is running.



The battery electrolyte contains corrosive sulphuric acid. Remove immediately if by accident applied to the skin. Wash with cloths and plenty of water. If the fluid gets into the eyes or other sensitive parts apply plenty of water and call for a doctor.

When the battery is charged, an explosive kind of gas generates. Short-circuit, open fire or sparks close to the battery may cause a heavy explosion. Always cut off the charge current before removing the charge terminals from the battery. Ventilate carefully, especially when charging in a closed room

Starting with auxiliary battery see 'SPECIAL CONDITIONS'.



**Main switch:**

The main switch of the battery 1 fig. 75 must be switched off before you begin with any repair work on the electrical system.



Fig. 74

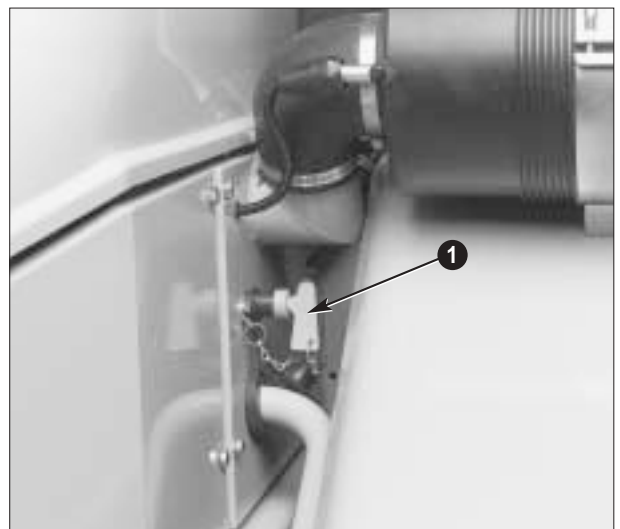

Fig. 75

The main switch should be off when you leave the machine, particularly for longer periods. The main switch is also used for disconnecting the battery voltage in an emergency, like fire.

**IMPORTANT!**

When the engine is running, the main switch must only be switched off in an emergency, because the electronic system might be damaged.

**Cleaning:**

(when required)

Clean the battery top and box with warm soapy water.

Take off the snap terminals. Clean terminals and pins and grease with non-corrosive vaseline.

**IMPORTANT!**

1. Battery and alternator cables must not be disconnected, when the engine is running. This may cause alternator defects.
2. Do not use a quick-charger system when the alternator is connected to the battery, as the rectifier diodes might be damaged.
3. The battery terminals must under no circumstances be confused. The poles are marked with a + sign and a – sign. A wrong connection will immediately damage the alterator rectifier diodes. When disconnecting the battery always disconnect the earth terminal first, and when remounting it attach earth the terminals last.
4. At electrical welding on the frame or equipment connected to the frame, the main switch must be switched off. Connect the welding unit as close to the welding point as possible.
5. Always switch of the main switch before carrying out any work on the electrical system.

**Fuses and relays:**

The fuses and relays are located in three places:

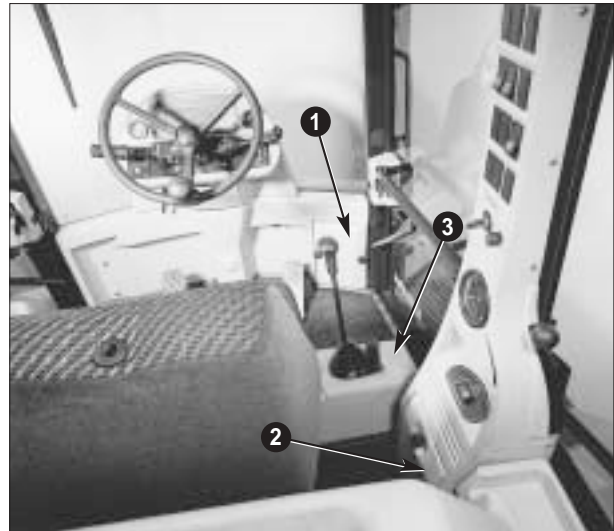
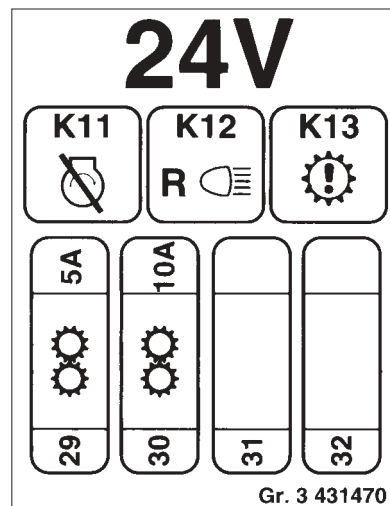

Fig. 76

Group 1: primarily head light, instrumentation light etc. (page 56).

Group 2: primarily functions for cab and engine (page 56)

Group 3: 24V, for the transmission only



Gr. 3

- |           |                    |
|-----------|--------------------|
| Fuse F29  | Kl. 15 24V         |
| Fuse F30  | Kl. 30 24 V        |
| Relay K11 | start barrier      |
| Relay K12 | reversing light    |
| Relay K13 | transmission error |

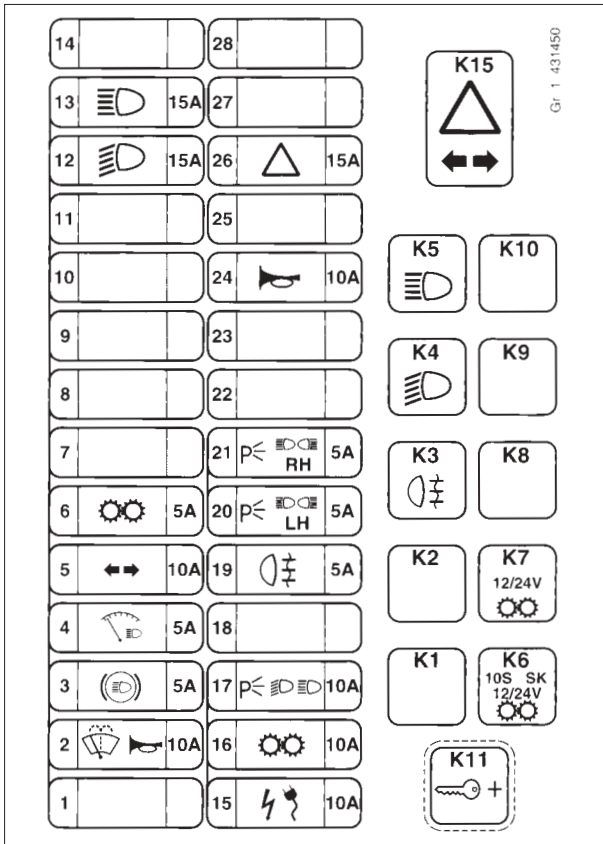

Gr. 1

**Gr. 1**

- Fuse F2: wiper/washer/horn for combi switch
- Fuse F3: brake light
- Fuse F4: instrumentation light
- Fuse F5: direction indicator
- Fuse F6: transmission Kl. 15
- Fuse F12: dipped beam
- Fuse F13: main beam
- Fuse F15: plug for hand lamp
- Fuse F16: transmission Kl.30
- Fuse F17: combi switch light
- Fuse F19: rear fog light
- Fuse F20: parking and left rear light
- Fuse F21: parking and right rear light
- Fuse F24: horn
- Fuse F26: hazard flashers
- Relay K3: rear fog light
- Relay K4: dipped beam
- Relay K5: main beam
- Relay K6: timer relay for transmission
- Relay K7: transmission
- Relay K11: relay for Kl. 15 Gr. 1
- Relay K15: direction indicator relay

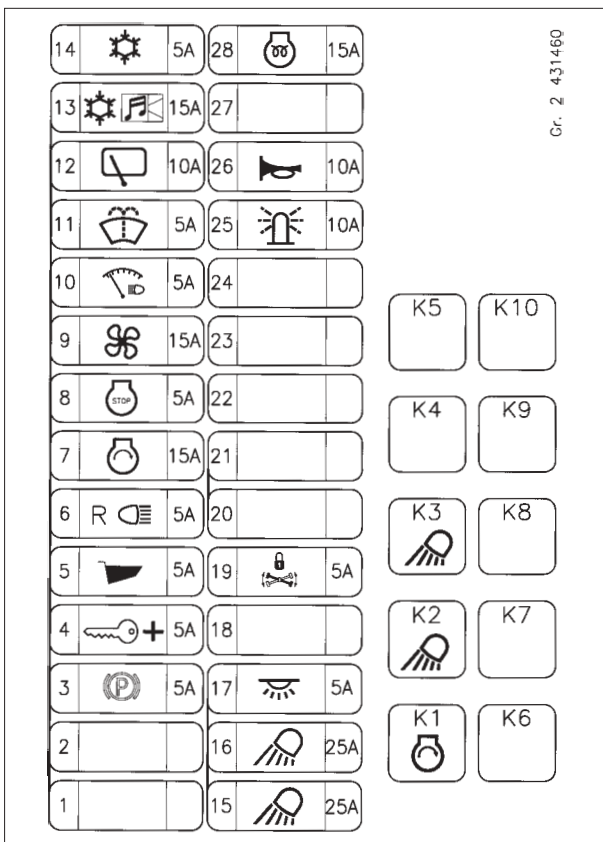

Gr. 2

**Gr. 2**

- Fuse F3: parking brake
- Fuse F4: for Kl. 15 Gr. 1 and 2
- Fuse F5: indicator/dumper body up
- Fuse F6: reversing light
- Fuse F7: for starter relay
- Fuse F8: stop spoole
- Fuse F9: fan motor
- Fuse F10: instrumentation light
- Fuse F11: washer
- Fuse F12: rear window wiper
- Fuse F13: radio / air-conditioning
- Fuse F14: air-conditioning
- Fuse F15: work light, right and left
- Fuse F16: work light, front and rear
- Fuse F17: interior light
- Fuse F19: locking the pending
- Fuse F25: warning beacon
- Fuse F26: horn
- Fuse F28: preheater / engine
- Relay K1: starter relay
- Relay K2: work light, right and left
- Relay K3: work light, front and rear

## Head light adjustment:

The adjustment of the lamps is essential for the sake of security when driving on public roads.

The lamps are adjusted by placing the empty machine 4 meters in front of a wall. The dipped beam light must fall approx. 3%.

For  $L = 4\text{m}$  the height measure  $H$  to the border between light and dark should be 120mm lower than the height measure  $B$  to the centre of the light.

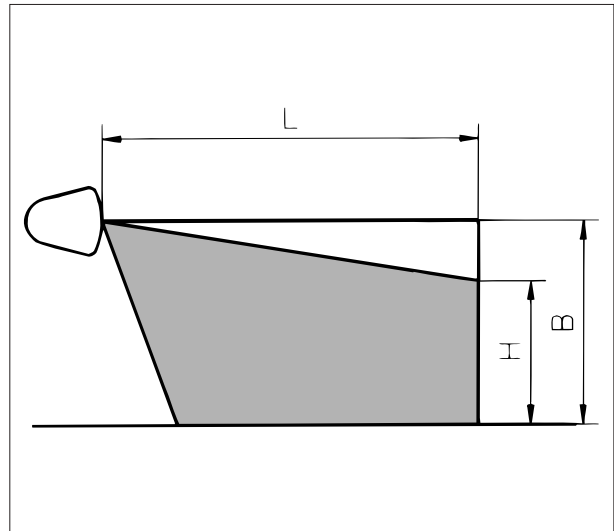

Fig. 79

## Adjustment see fig. 80

All four screws contribute to correct lamp adjustment.

To replace bulbs, dismount the covers behind the lamps to access the bulbs.



Fig. 80



## HYDRAULIC SYSTEM

The hydraulic tank is integrated in the left front frame.



**Hydraulic oil level:**  
(every 50 hours)

The oil level should be in the middle of the oil level glass 1 fig. 81.

Loosen the filler cap 2 fig. 82 to release the tank pressure.



At working temperature the hydraulic tank is under pressure. Warm oil may cause serious scalds.

Only remove the filler cap when the engine is stopped and the tank cooled so far that it is possible to hold the cap without burning your hand.



**Hydraulic filter:**  
(every 400 hours)

Loosen filler cap 2 to release tank pressure. Remove cover 1 and lift the filter out. Unscrew the nut 2 fig. 83, remove cartridge 3 fig. 83 and discard it.

Clean the magnetic rod thoroughly, check and, if necessary, fit new O-ring 4 and 5 fig. 83. Install a new cartridge.

Remount the filler 2 fig. 82 by rinsing in kerosene or diluent. Remount when dry.

**Draining of hydraulic tank:**  
(every 1000 or once a year)

Drain water and sediment from the hydraulic tank by carefully unscrewing the plug 2 fig. 81 after the machine has been standing still for 24 hours - tilted towards the corner where the plug is situated.

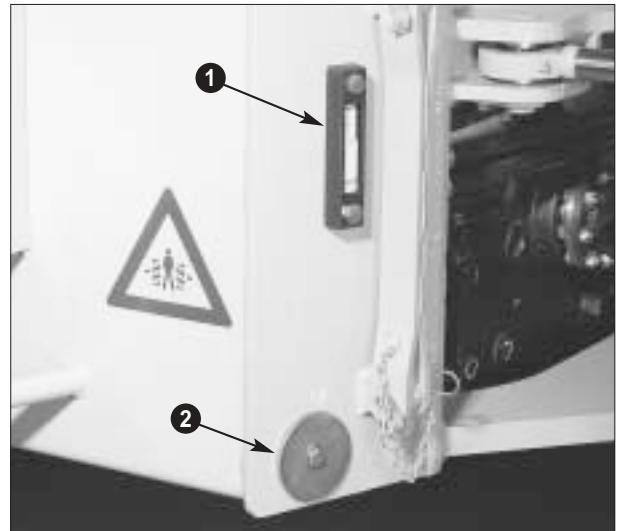

Fig. 81

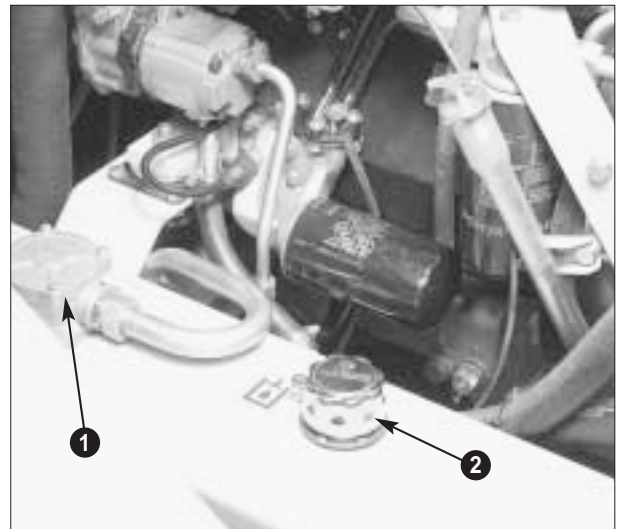

Fig. 82

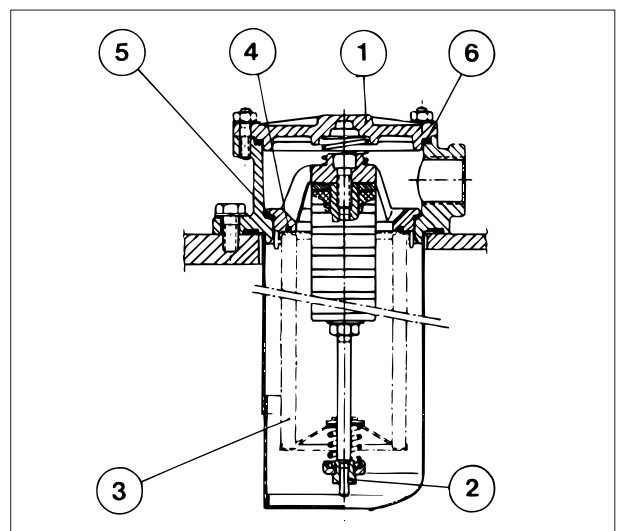

Fig. 83



**Hydraulic oil change:**  
(every 2000 hours or 2 years)



Hot oil may cause scalds. Avoid direct contact!

Tip the dumper body to max. height and stop the engine. Unscrew the cover 2 fig. 81 and make sure that the draining can take place in a safe way.

When the tank is empty, lower the body to allow for greatest possible amount of oil to drain.

Clean for water and sediment.

Close the drain plug and fill with the specified oil (page 61) to the top edge of the oil level glass 1 fig. 81.

Capacity: approx. 90 litres.

Start the engine, activate all hydraulic cylinders by operating levers until filled with oil and free from air.

Stop the engine and fill until the oil level is in the middle of the oil level glass.

**IMPORTANT!**

When servicing the hydraulic system always release the system pressure by loosening the plug 2 fig. 82. It is imperative that the machine is clean as any impurity may ruin the hydraulic components and cause a break-down.

**Release of hydraulic pressure**



At working temperature the hydraulic tank is under pressure. Warm oil may cause serious scalds.

Remove the filler cap only when the engine is stopped and the tank is cooled down so you can hold the cap without being burnt.

The hydraulic system for the tipping function and the brake system of the machine may be under pressure, also when the engine is stopped. Before any repair work/service can take place, make sure that the systems are completely released of pressure.

**Release of tipping function:**

Lower the body completely or raise to upper position and mount support device. Stop the engine and dismount the cover of the hydraulic tank. Activate the lever for the lifting function completely several times to both sides and the lifting system is pressure-released.

**Release of brake hydraulics:**

Before any repairs of the brake system make sure that the machine is placed on a plane level with activated parking brake and stop blocks at the wheels. Stop the engine. Activate the brake pedal at least 30 times with intervals of 1 sec., and the system is pressure released.



**CAB**

The rear window grill 1 is fitted with four rubber retainers, so that it can be dismantled without use of tools.

Dismount and replace or clean the dust filters 2 every 400 hours or if the air circulation in the cab is reduced.

**Cleaning:**

The dry filter can be cleaned with compressed air from inside.



Wear safety mask or goggles when cleaning with compressed air. The pressure must not exceed 205 kPa (2 bar), as a higher pressure can damage the filter.

However, if the filter is very dirty or damp, it may be washed in a non-foaming detergent. Let the element soak in the detergent for 10 - 15 minutes, then move it in the detergent to remove loosened particles. Rinse the element with clean water from the inside and let it dry.

Check that the filter is intact before mounting it.

**NOTE:**

Never mount a wet filter element.

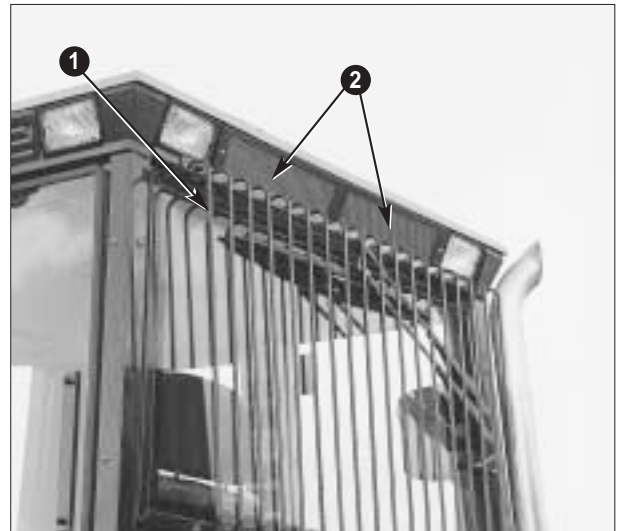
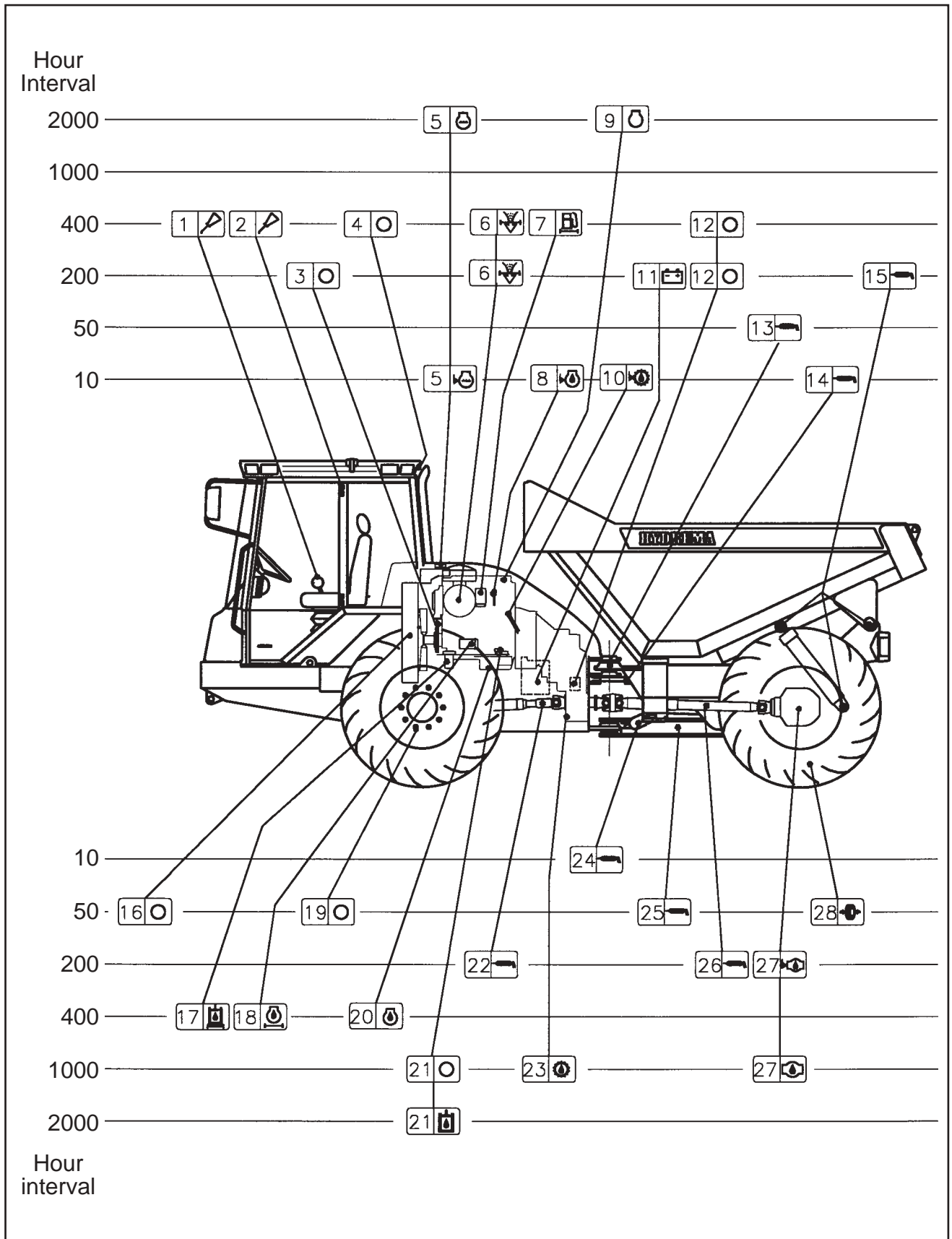

Fig. 84





Interval	Pos. No.	Lubrication and maintenance	No. of lubr. points	Check	Clean	Lubricate	Change	Adjust	Page
<b>Every 10 hours or every day</b>	5	Coolant level							49
	8	Engine oil level							45
	10	Transmission oil level							51
	14	Steering cylinders	4						
	24	Stabilizer	4						
<b>Every 50 hours or weekly</b>	13	Upper pivot bearing	1						
	16	Radiator							50
	19	Tightening torque for wheel nuts: 500 Nm							
	25	Bearings pendulum bar	2						
	28	Tyre pressure: 600/55x26.5 17.5x25EM Bar: front 2.0/rear 2.7 front 2.75/rear 5.25							14
<b>Every 200 hours</b>	3	Tightening of alternator belt							54
	6	Air filter (or whenever indicator lights)							48
	11	Battery fluid level							54
	12	Drain water in fuel pre-filter							46
	15	Tipping cylinders	6						
	22	Front prop shaft	2						
	26	Rear prop shaft	3						
	27	Differential and wheel hub oil level							52
<b>Every 400 hours</b>	1	Tipping handle and cable	1						
	2	Door hinges	4						
	4	Air filter for cab							60
	6	Air filter for engine							48
	7	Fuel filter							47
	12	Drain fuel tank Clean lift pump strain							46
	17	Hydraulic oil filter Magnet rod and filler cab							58
	18	Engine oil filter							45
	20	Engine oil							45
<b>Every 1000 hours or max. 1 year</b>	21	Drain hydraulic tank							58
	23	Transmission oil Transmission oil filter							51
	27	Differential and wheel hub front/rear							52
<b>Every 2000 hours or max. 2 years</b>	5	Coolant							49
	9	Engine valve tip clearance Engine atomizers							
	21	Hydraulic oil							59

= Axle oil

= Engine oil

= Transmission oil

= Hydraulic oil

= Coolant

= Fuel

= Induction

= Battery

= Parking brake

= Lubrication (oil)

= Lubrication (grease)

= Other servicing

PROBLEM	CAUSE	SOLUTION
Engine does not start	Machine is in gear Battery voltage is too low Defective fuel supply Electrical stop on fuel pump defective Other defects	Shift to neutral Check battery and connections Check fuel capacity and connections Check connections Contact HYDREMA Service
Engine smoke is black	Air filter clogged up Fuel system or turbo-charger defective Wrong fuel type	Replace or clean air filter Contact HYDREMA Service Replace fuel and fuel filter
Engine temperature too high	Radiator clogged up Not enough coolant Defective thermostat or water pump Defective cold start system	Clean radiator Fill with coolant Contact HYDREMA Service Contact HYDREMA Service
Engine starts and stops	Dirty fuel filter or air filter Air in the fuel system	Replace fuel filter or air filter Check connections
Alternator charges irregularly	Defective or loose alternator belt Defective alternator	Replace or adjust alternator belt Contact HYDREMA Service
Transmission overheated	Too much transmission oil Radiator clogged up Gear selection too high	Check oil level while engine is running Drain excess of oil Clean radiator Select a lower gear



Lined writing area on the left side of the page.

Lined writing area on the right side of the page.